

B59e

B59b

B59f

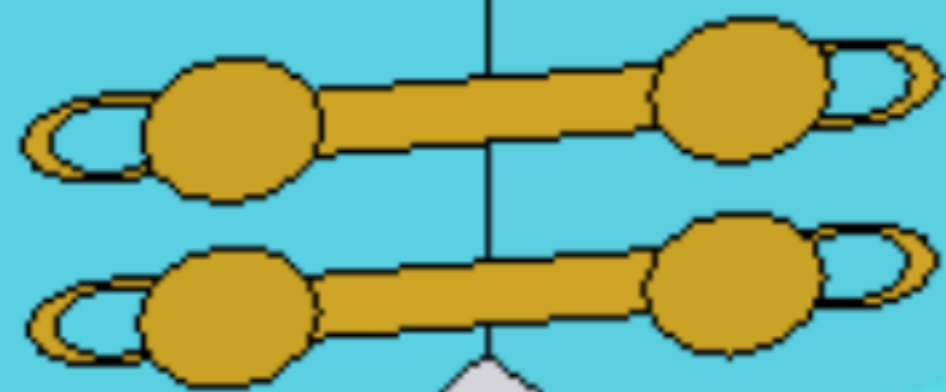

B59

B59a

B60

B60a

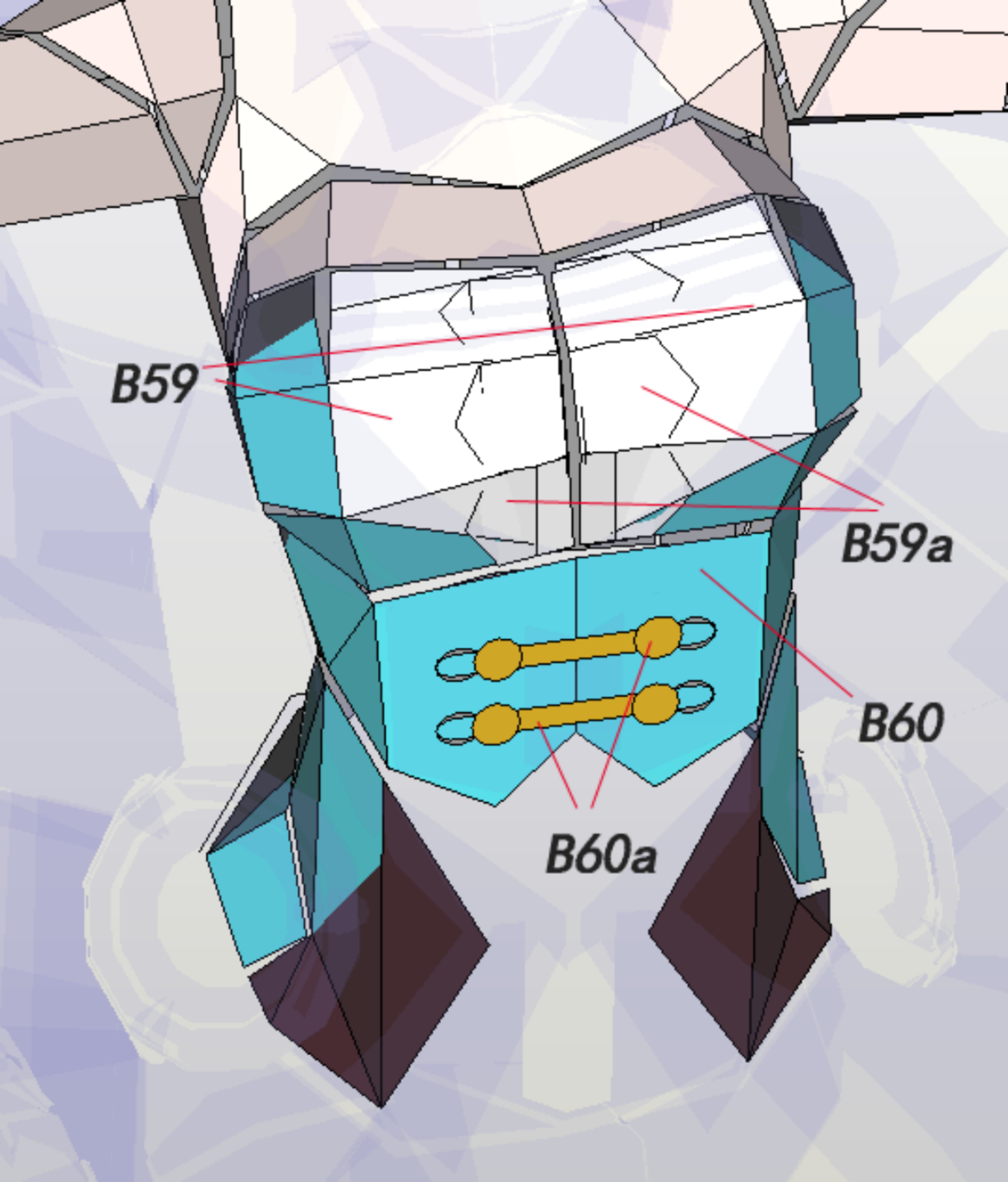

红色圆圈处为粘点

B59b

B59c

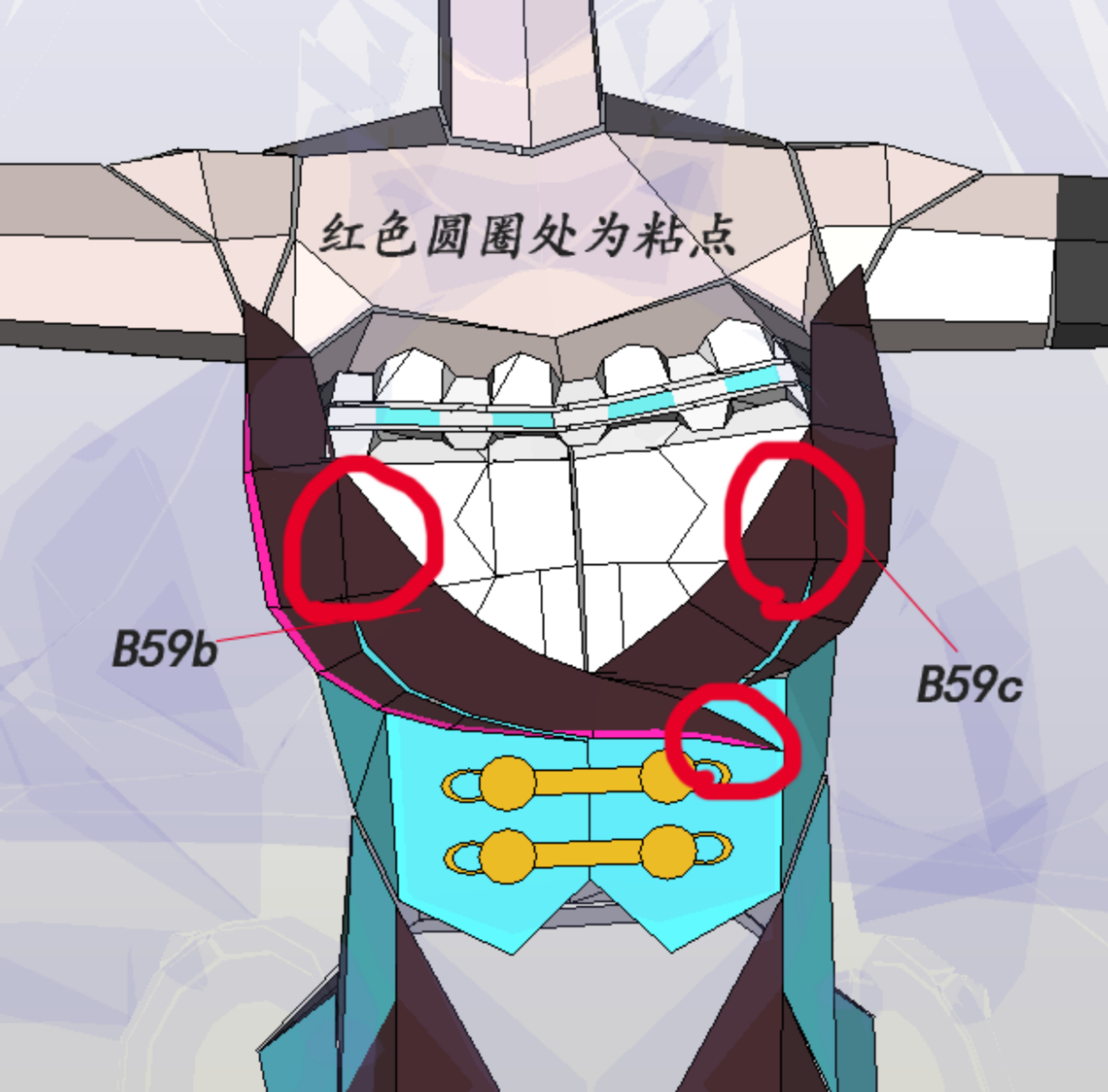

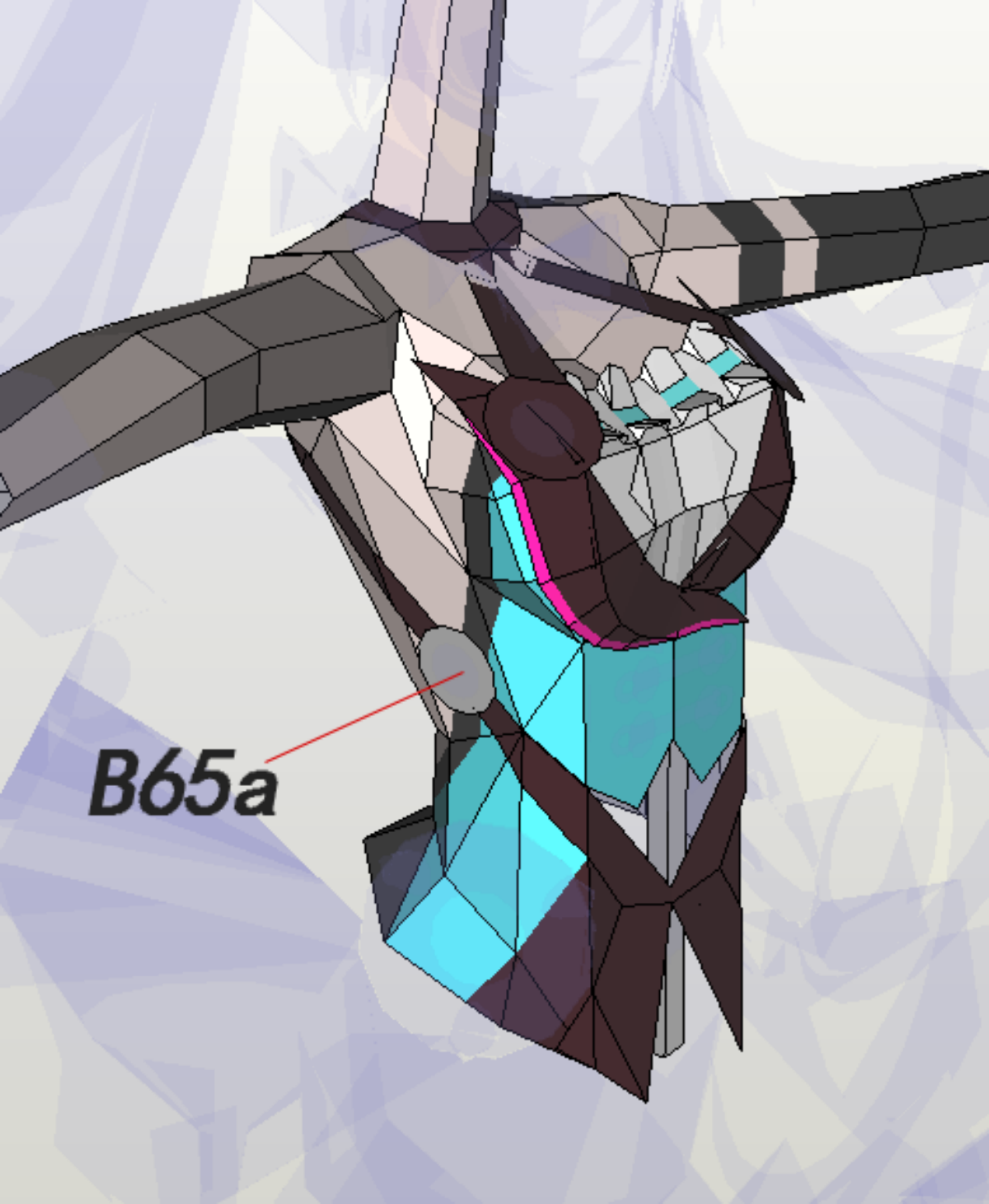

B65a

B65

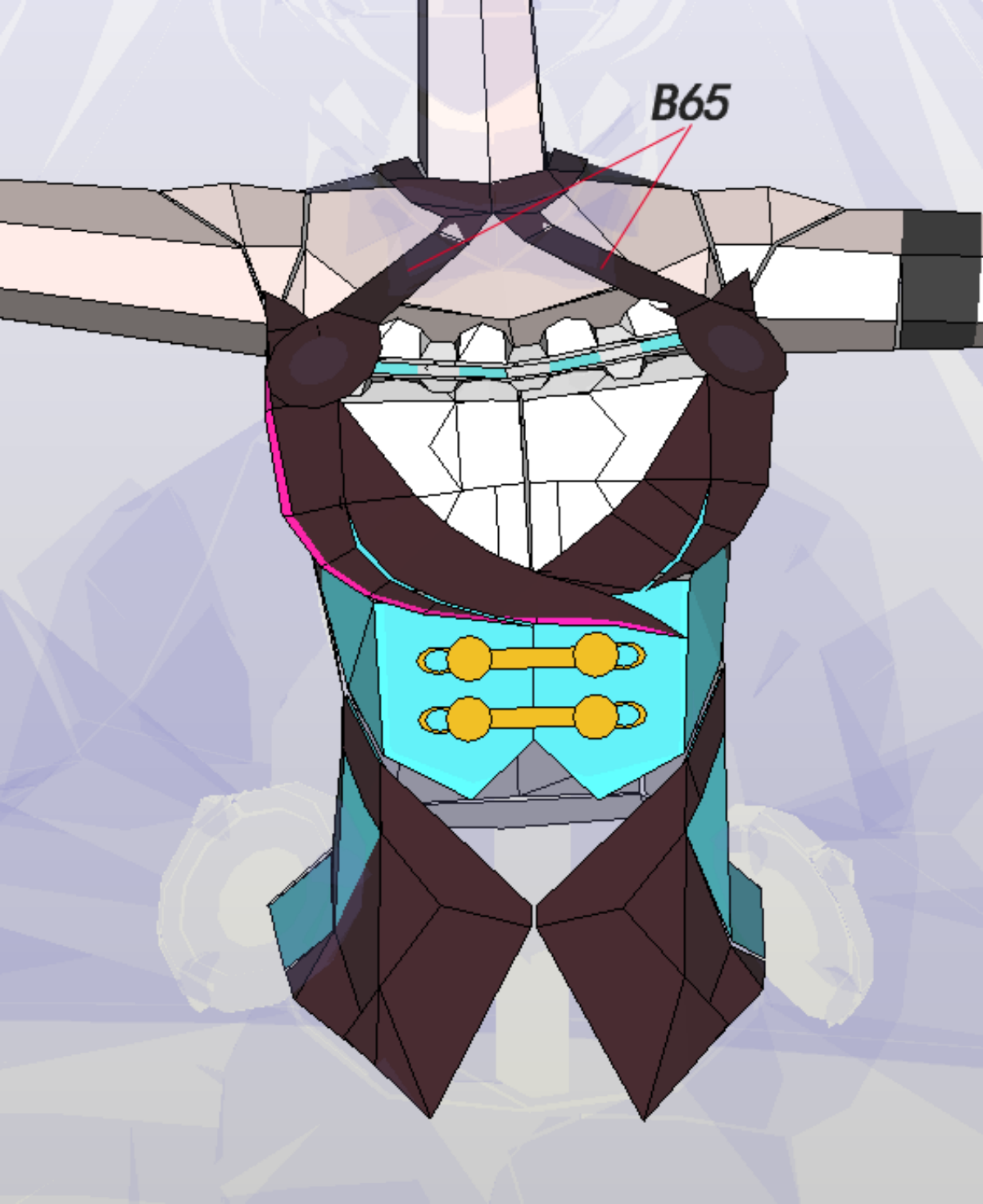



B66

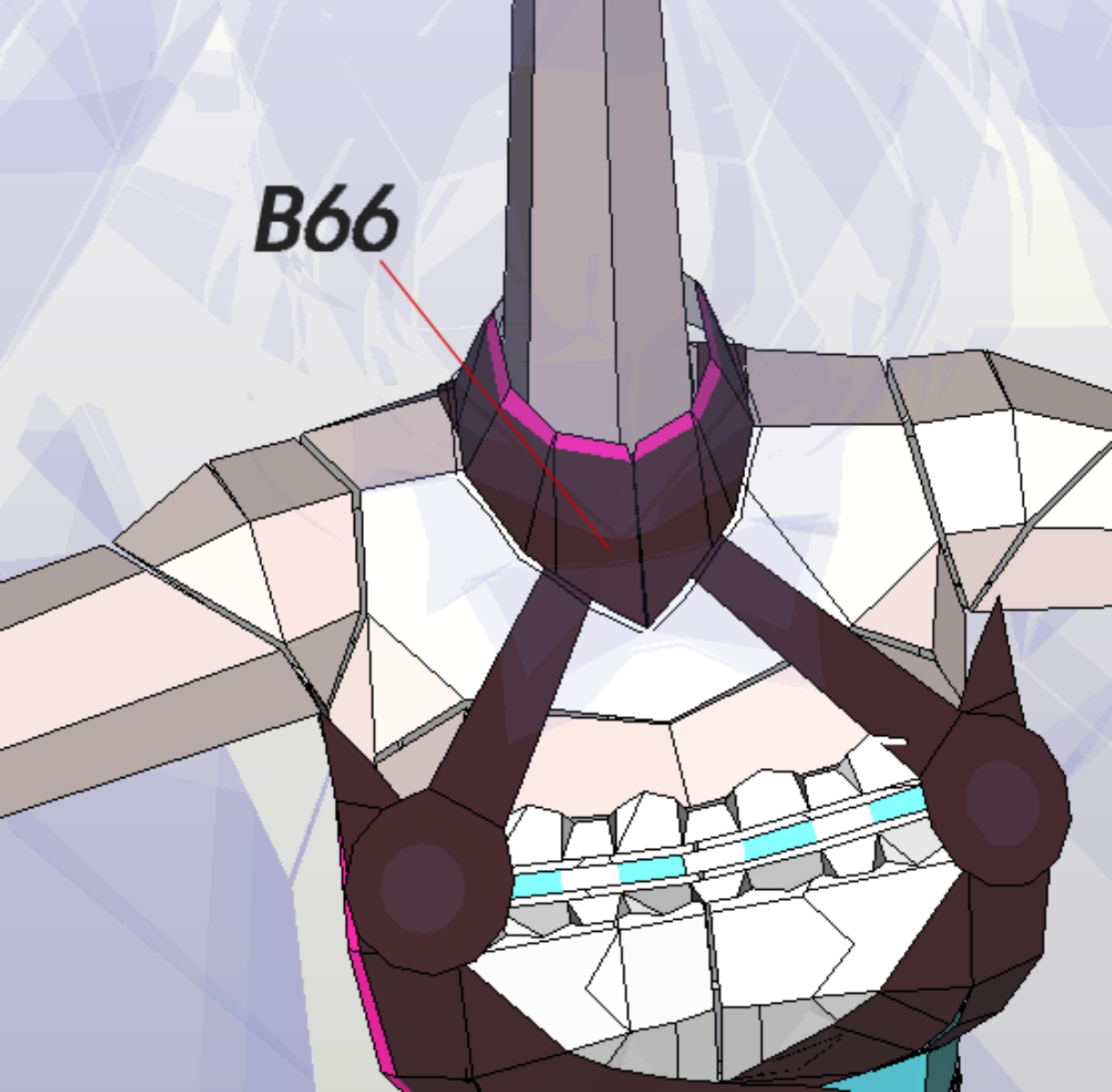

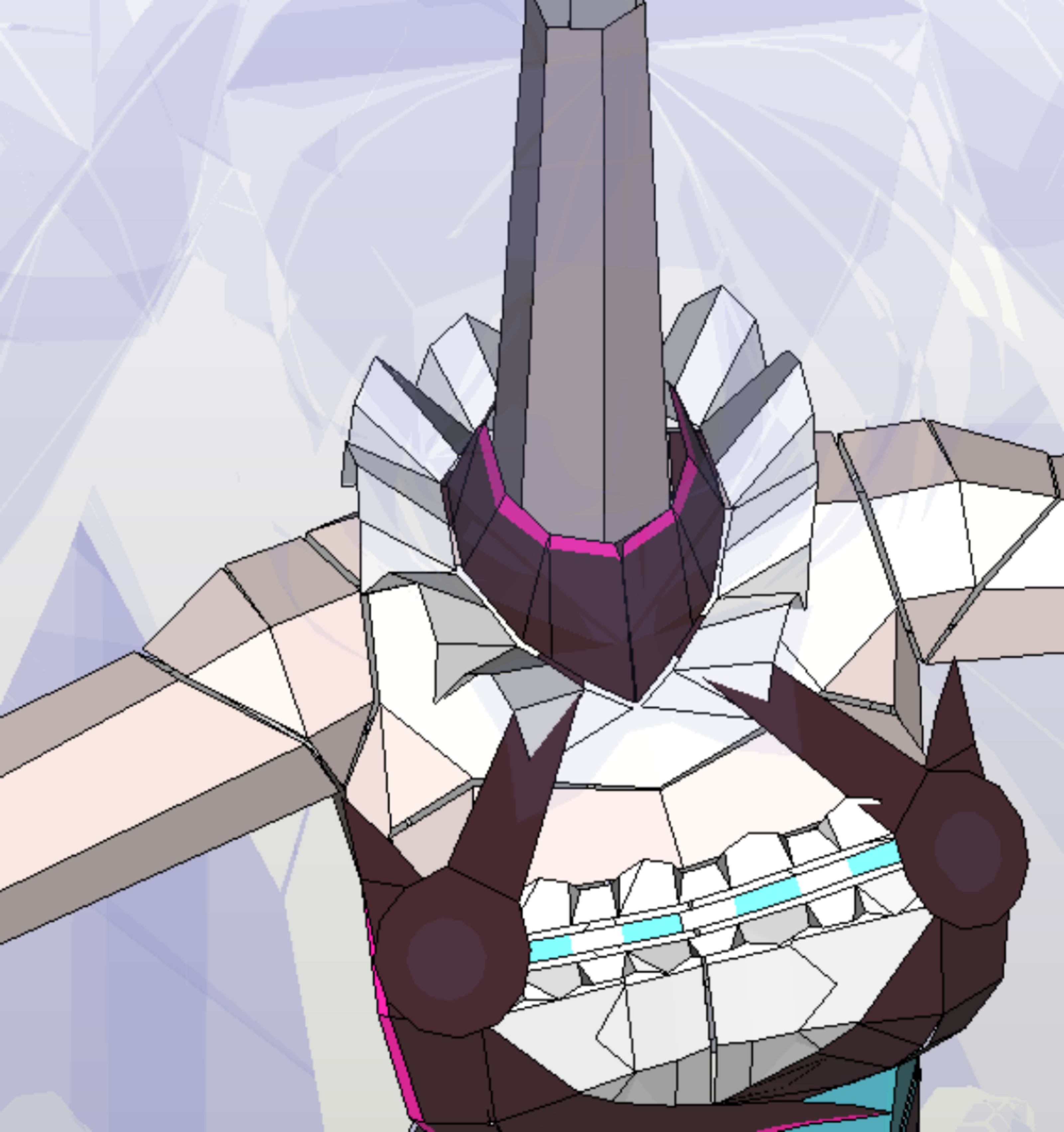

B67

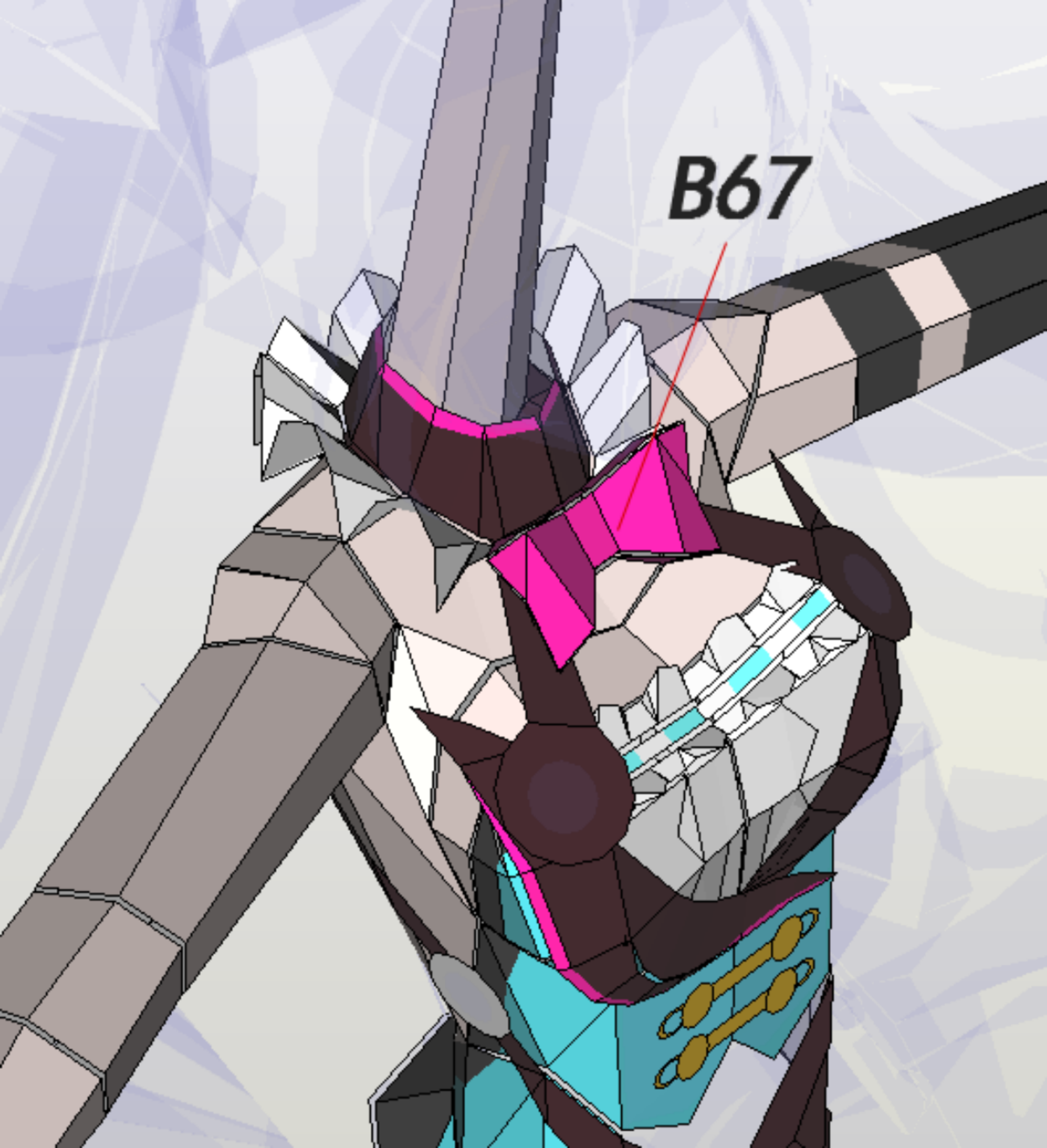

B66



B67

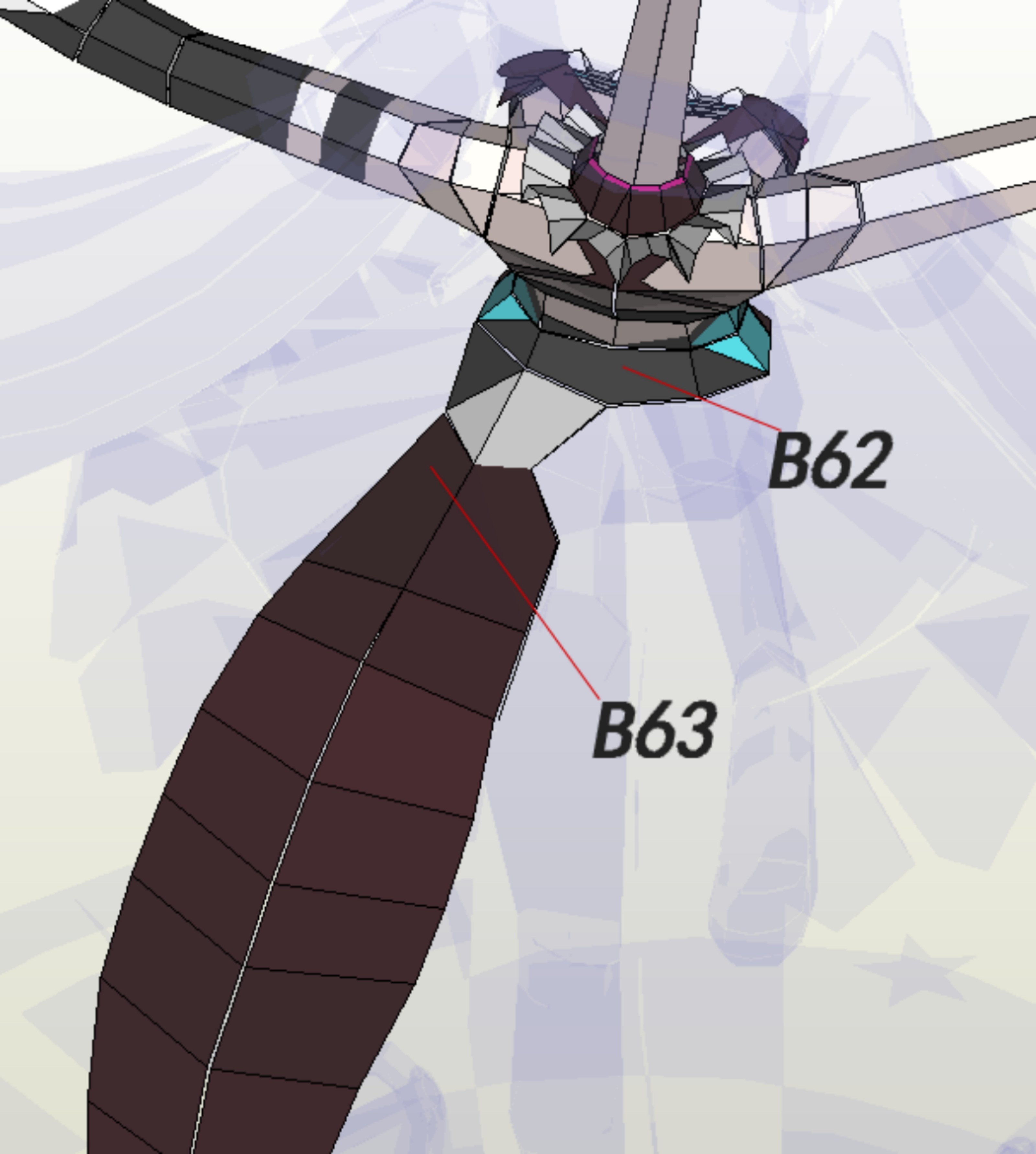

B62

B63

B63

B62

B64

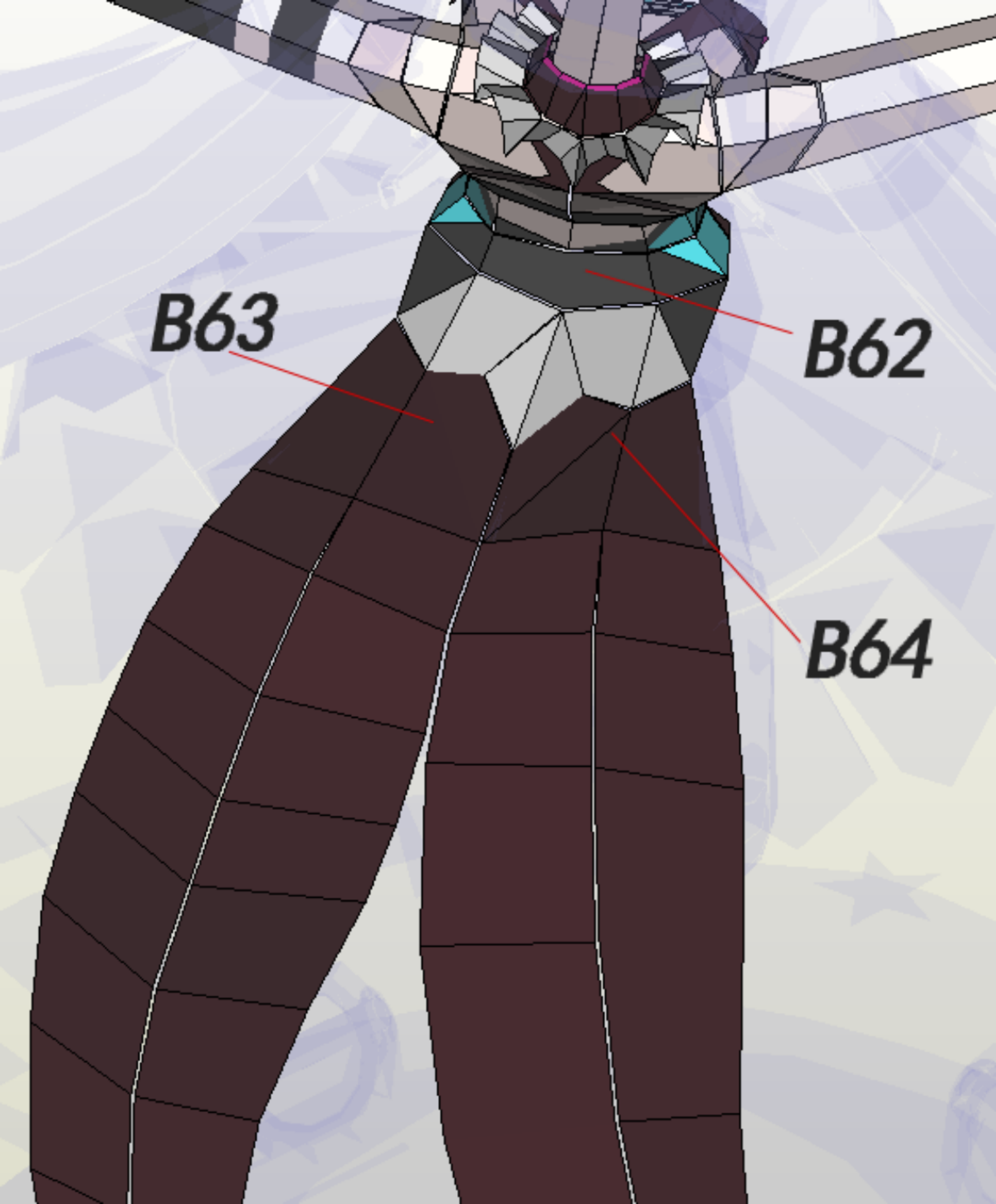

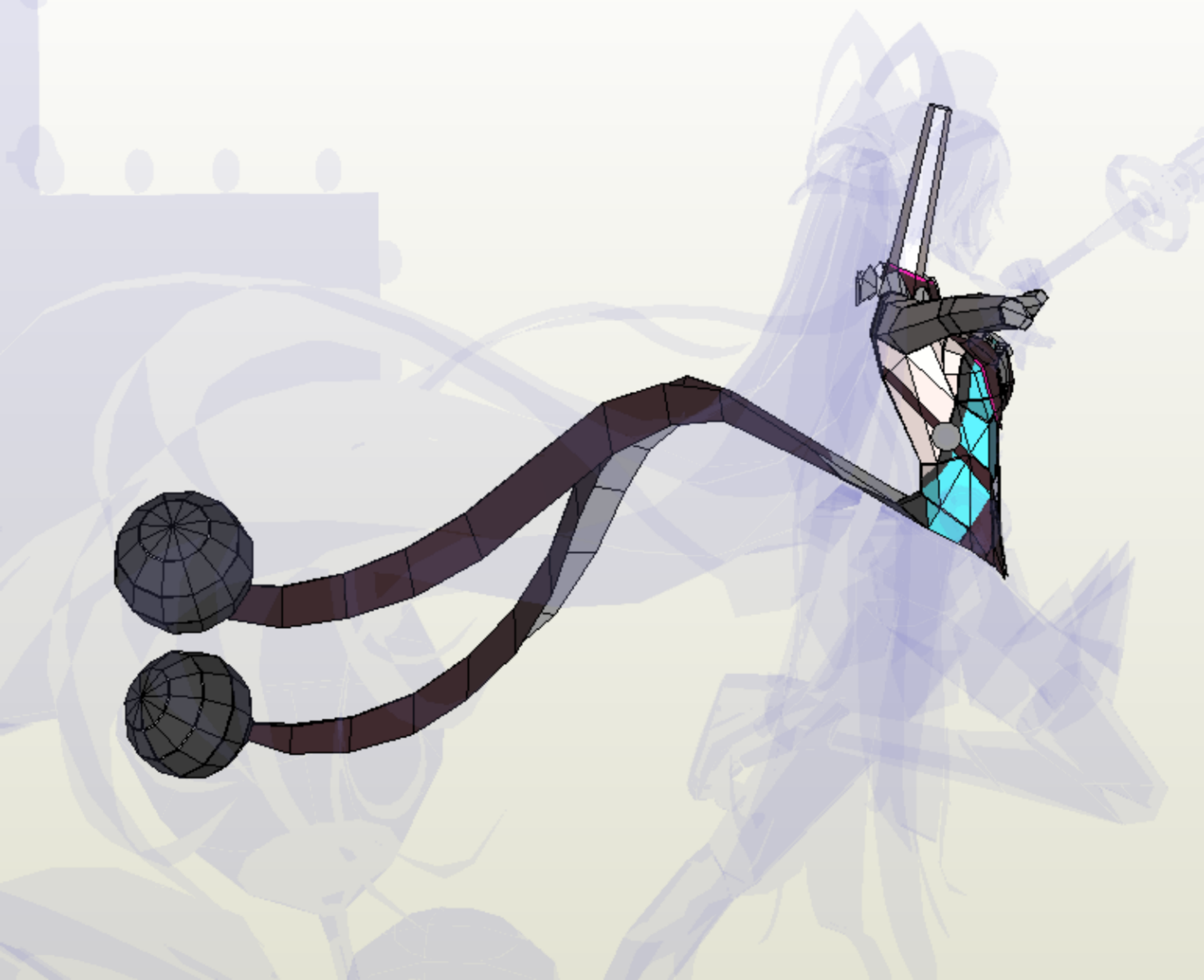



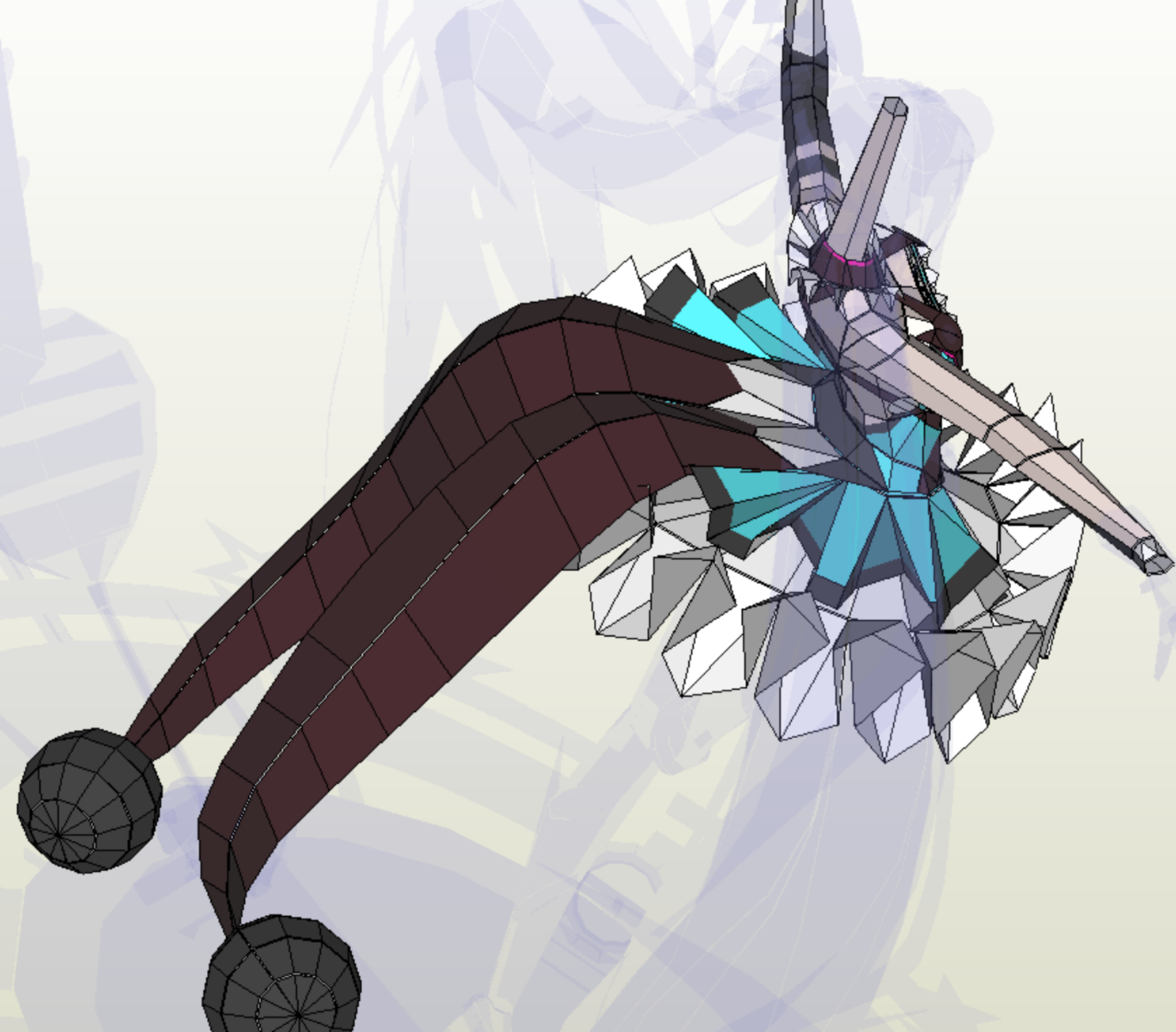



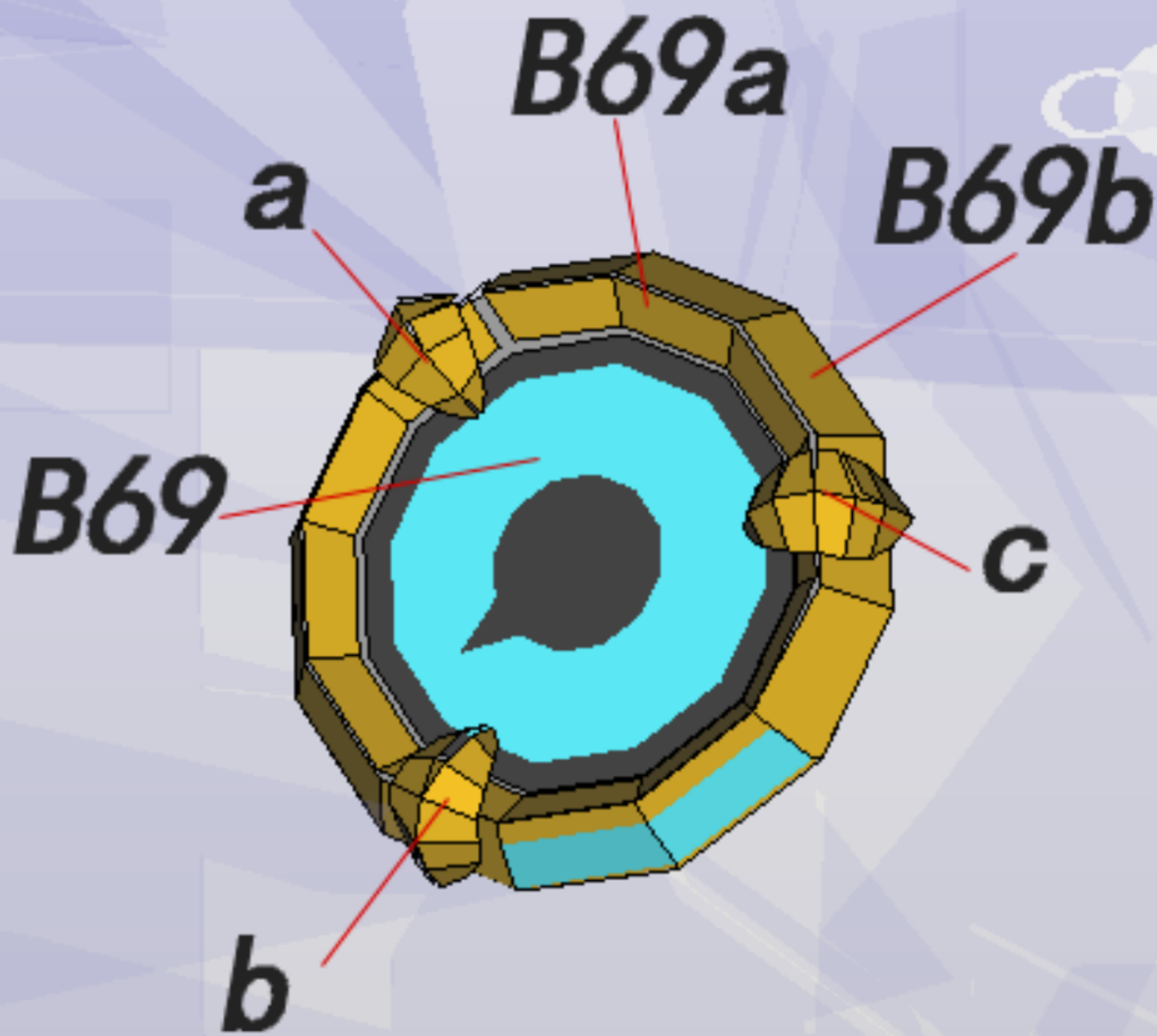

B69d

B69b

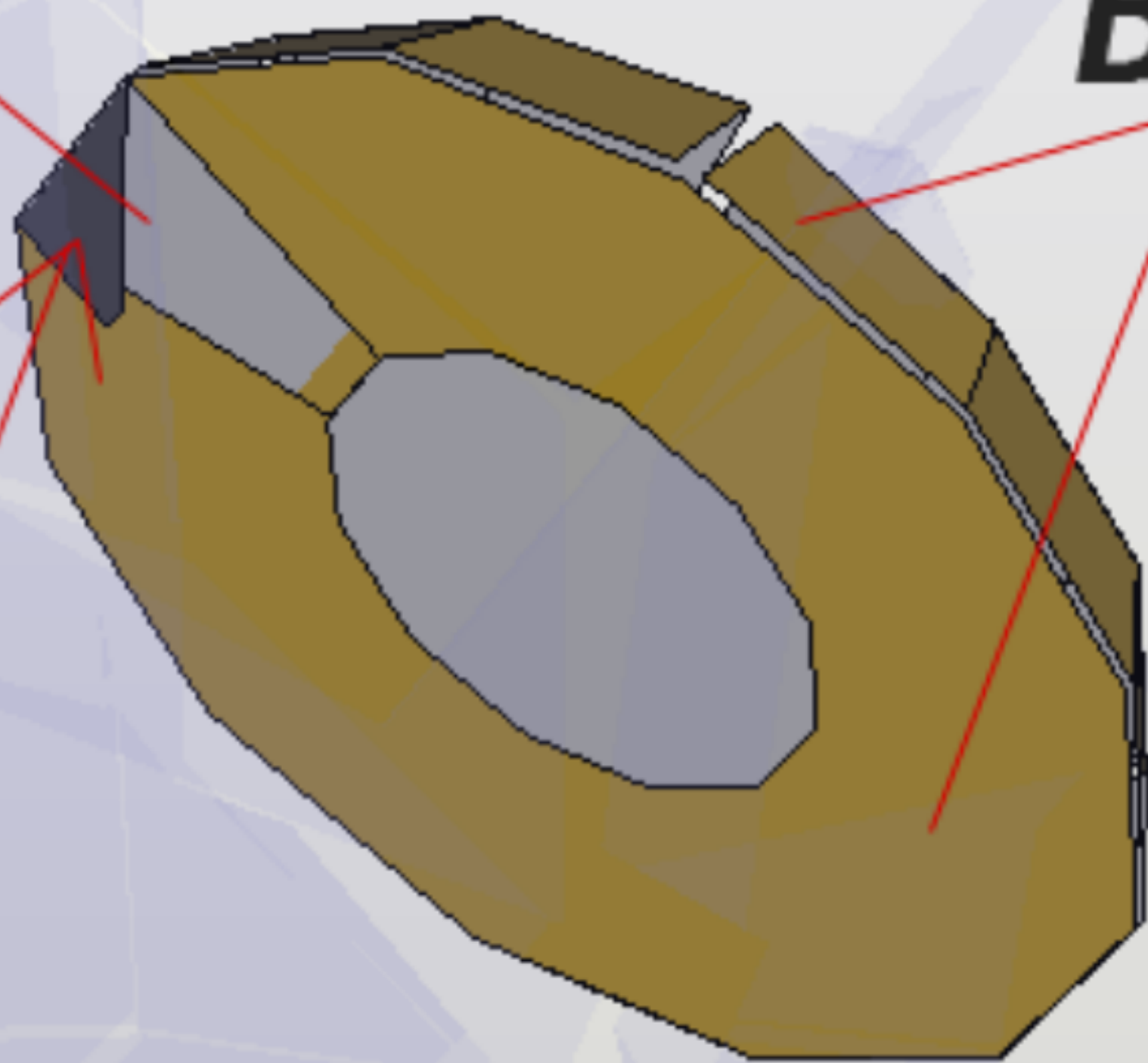

此处与衣服沾合

A68a

A68

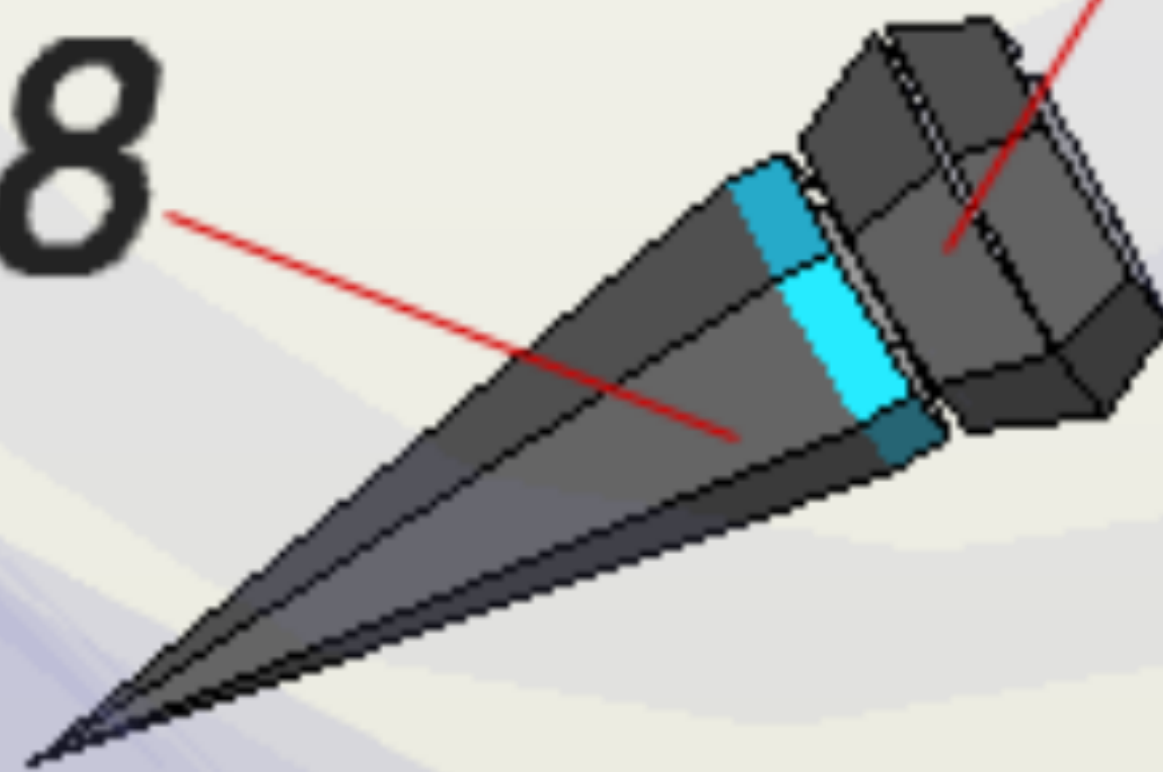

A69

A69a

A69b

A69c

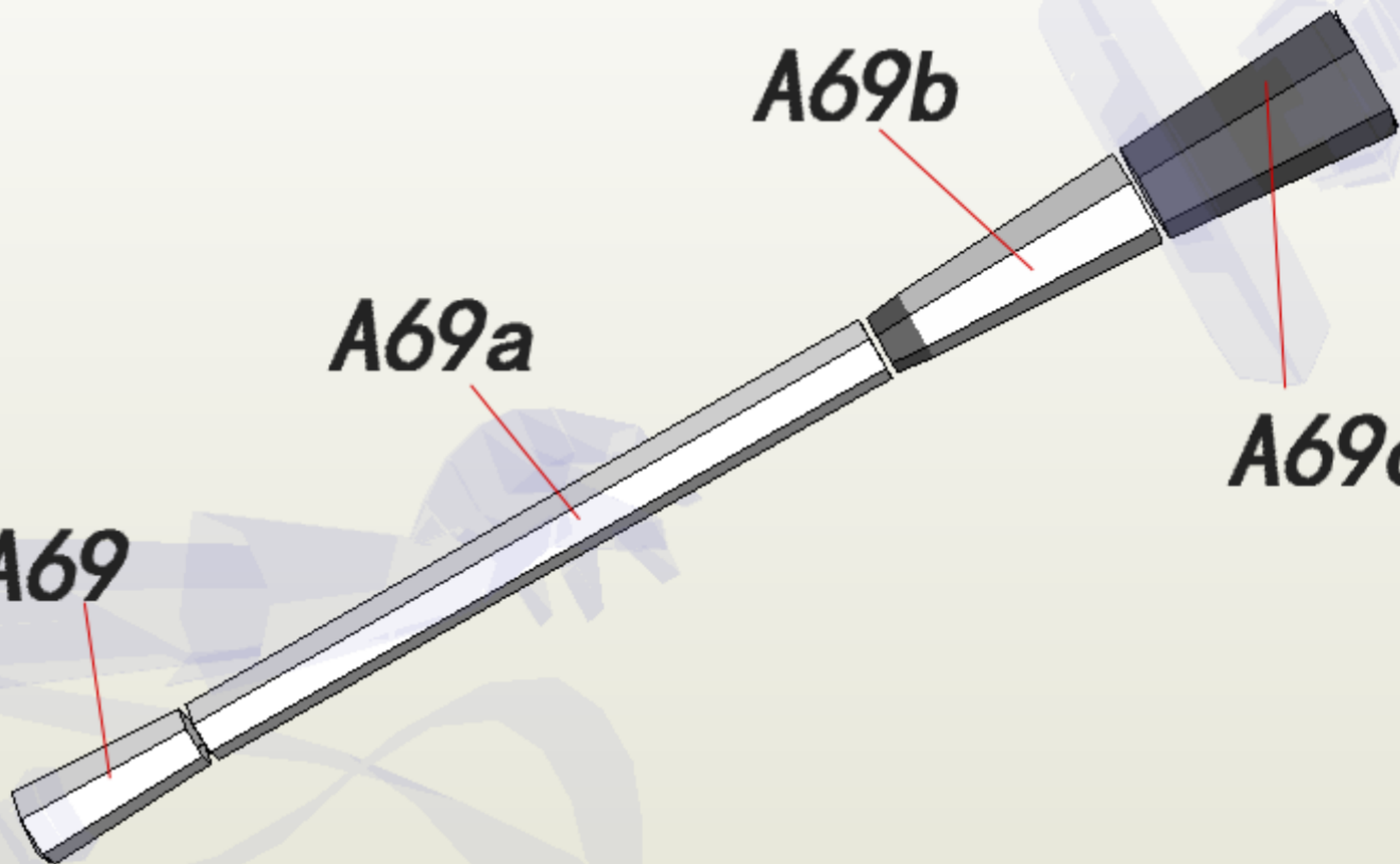

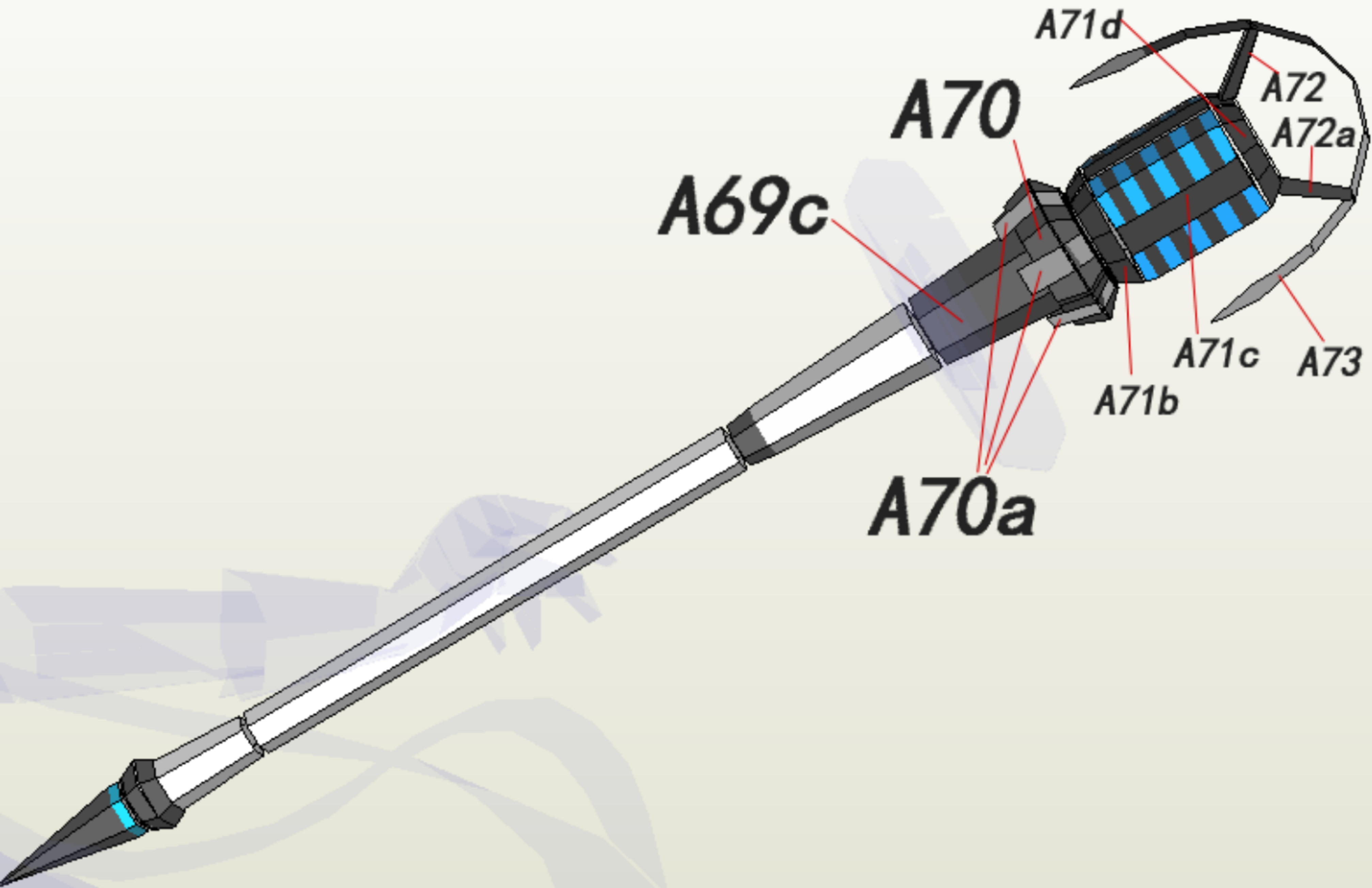

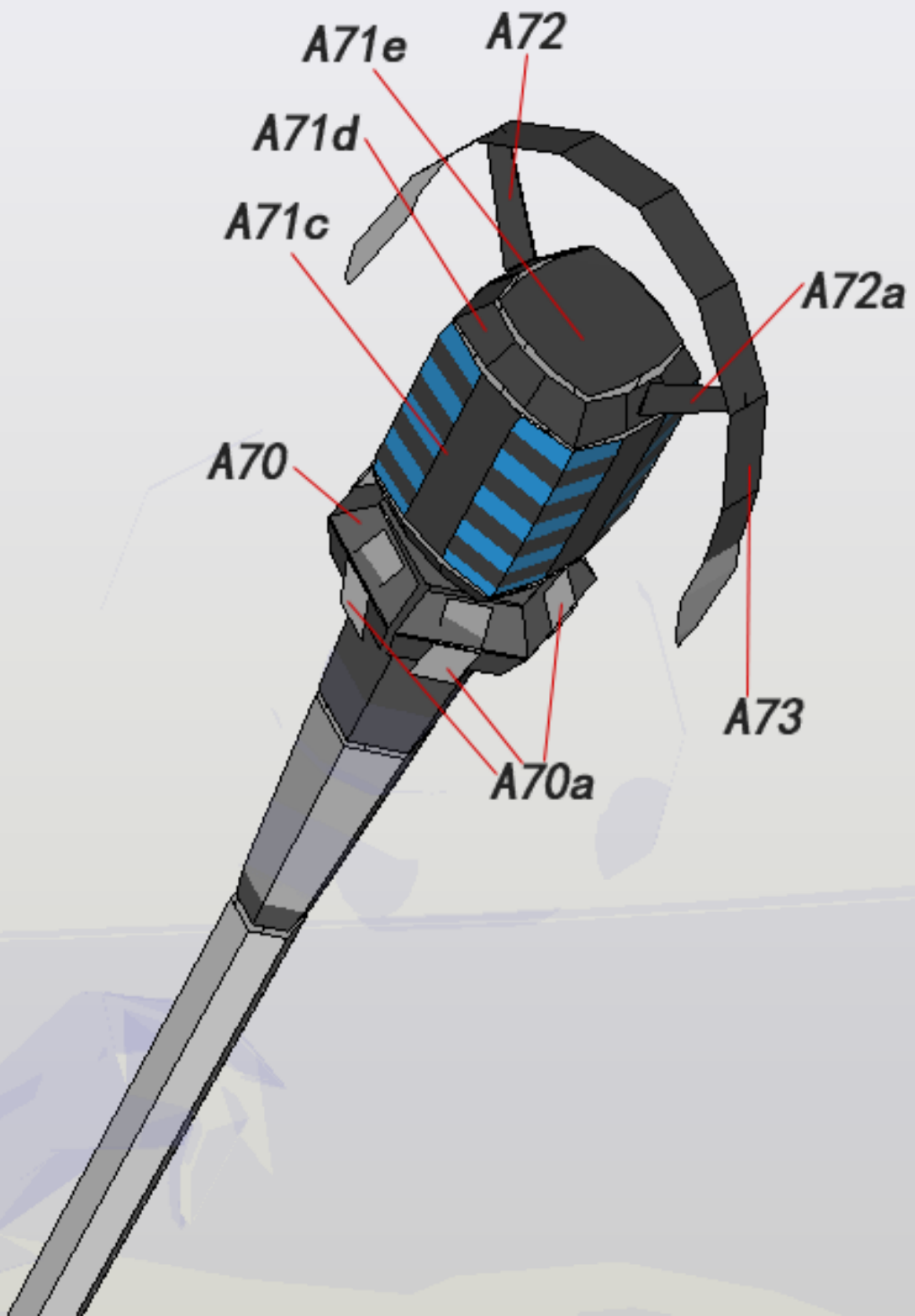

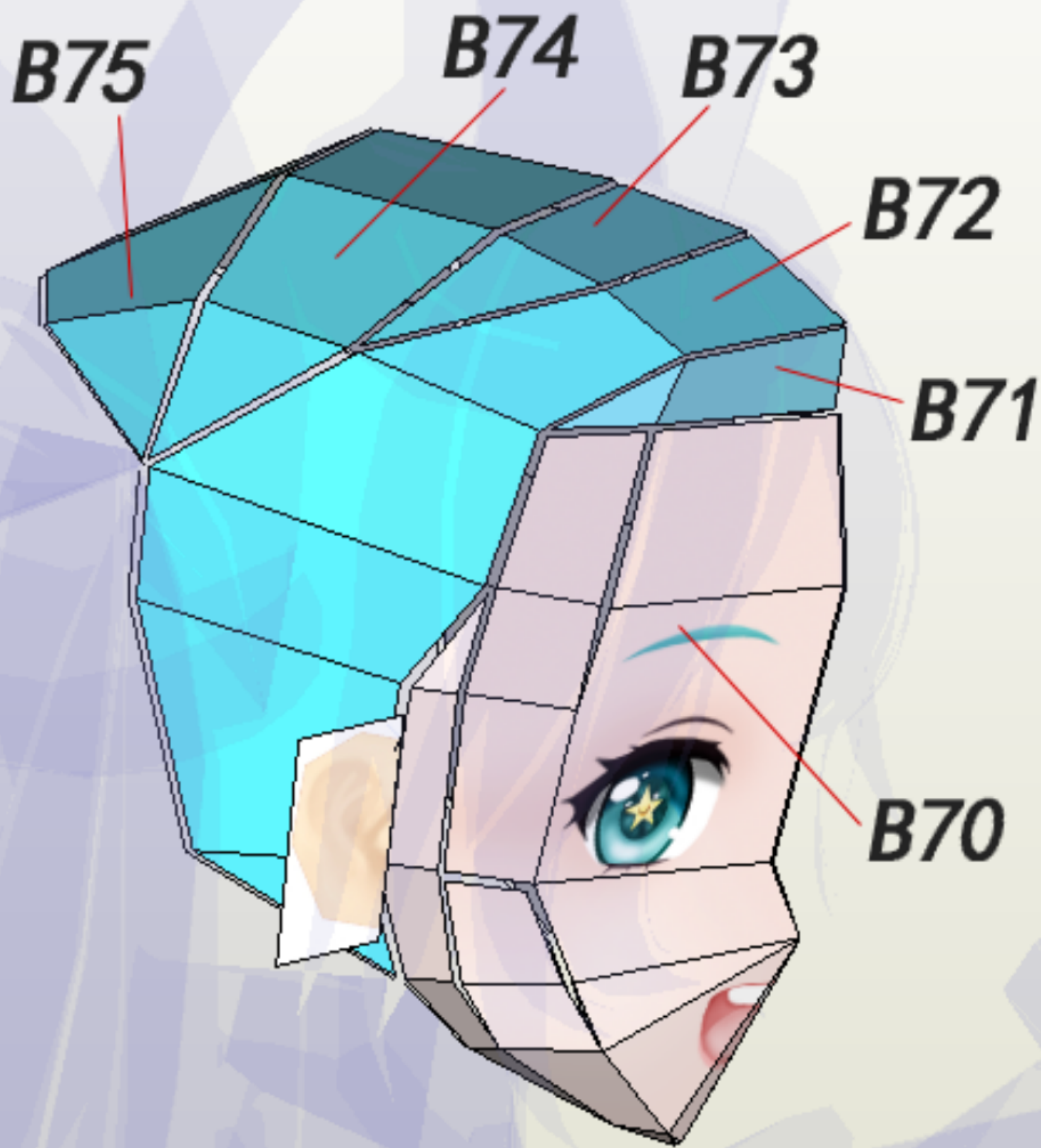

B80

B79 B80

需要加固

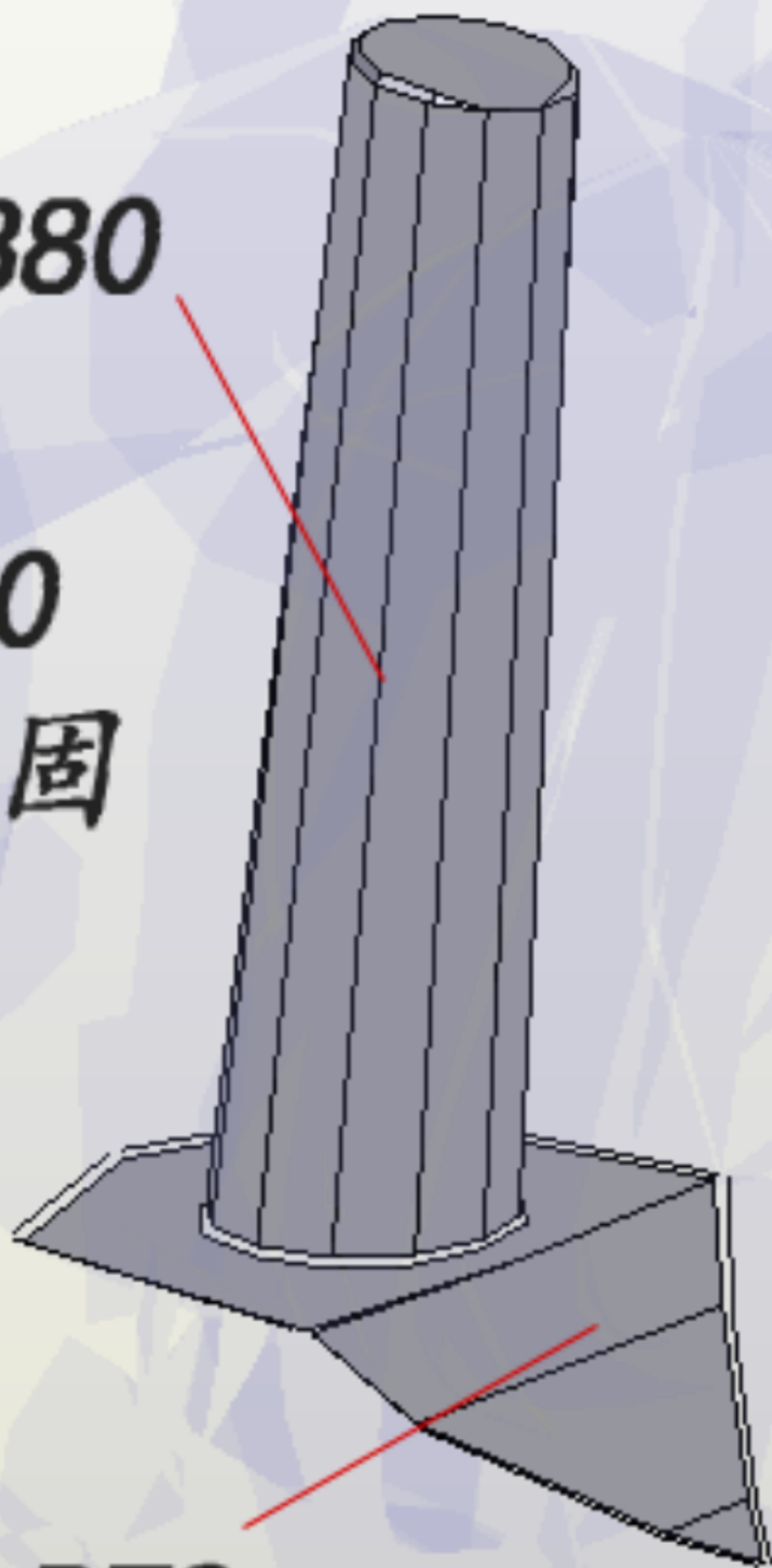

B79

B75

B74

B76

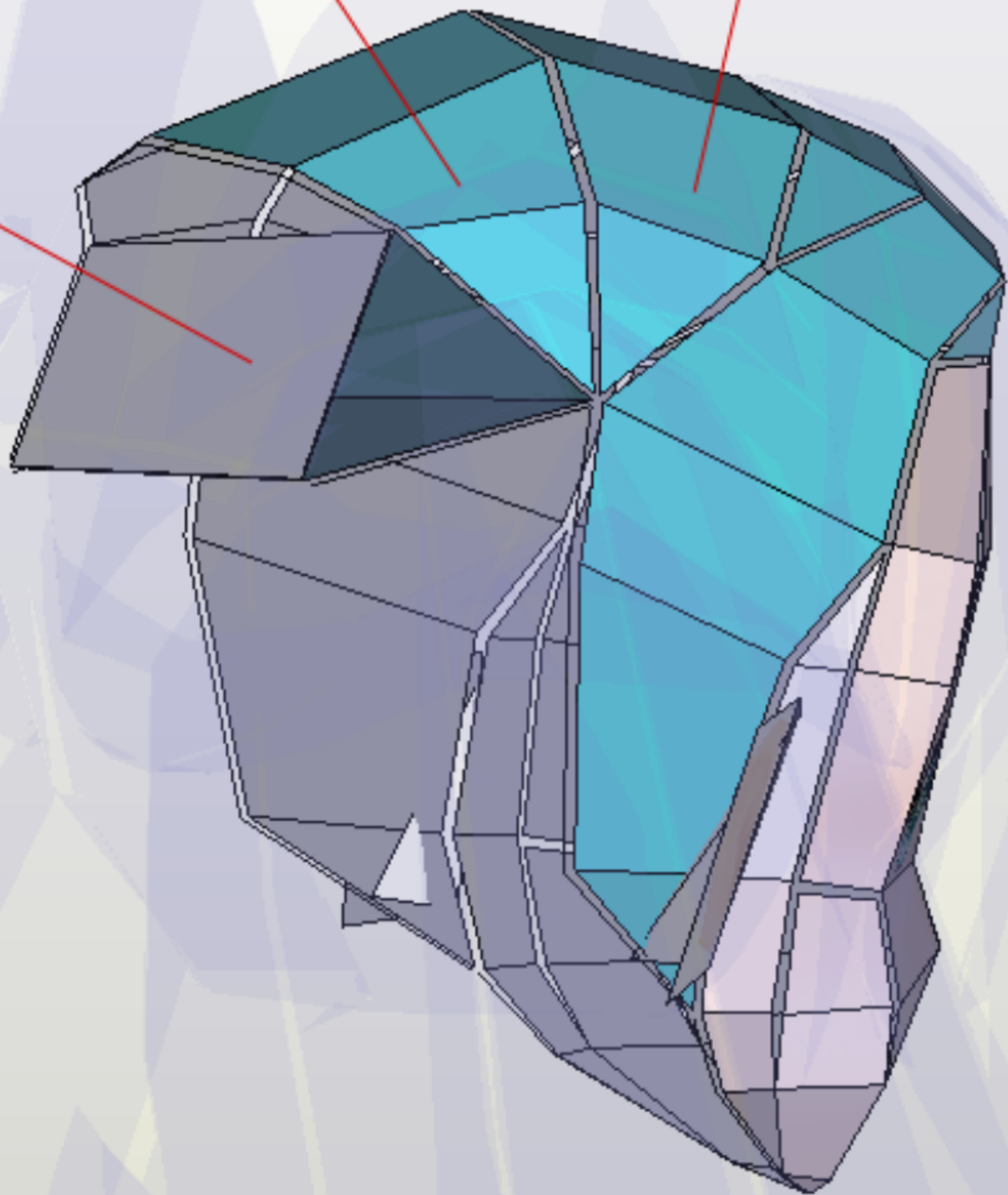

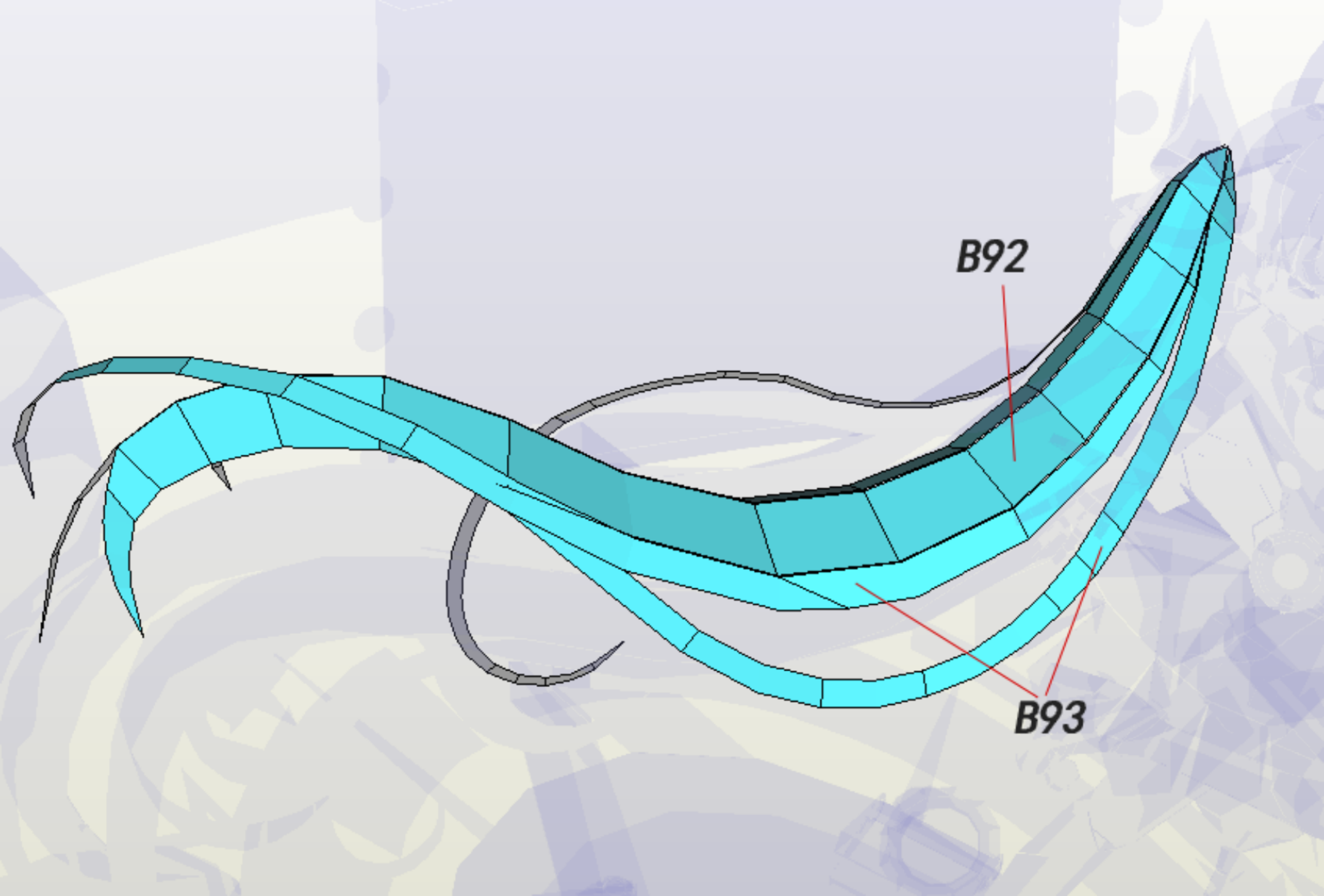

B92

B93

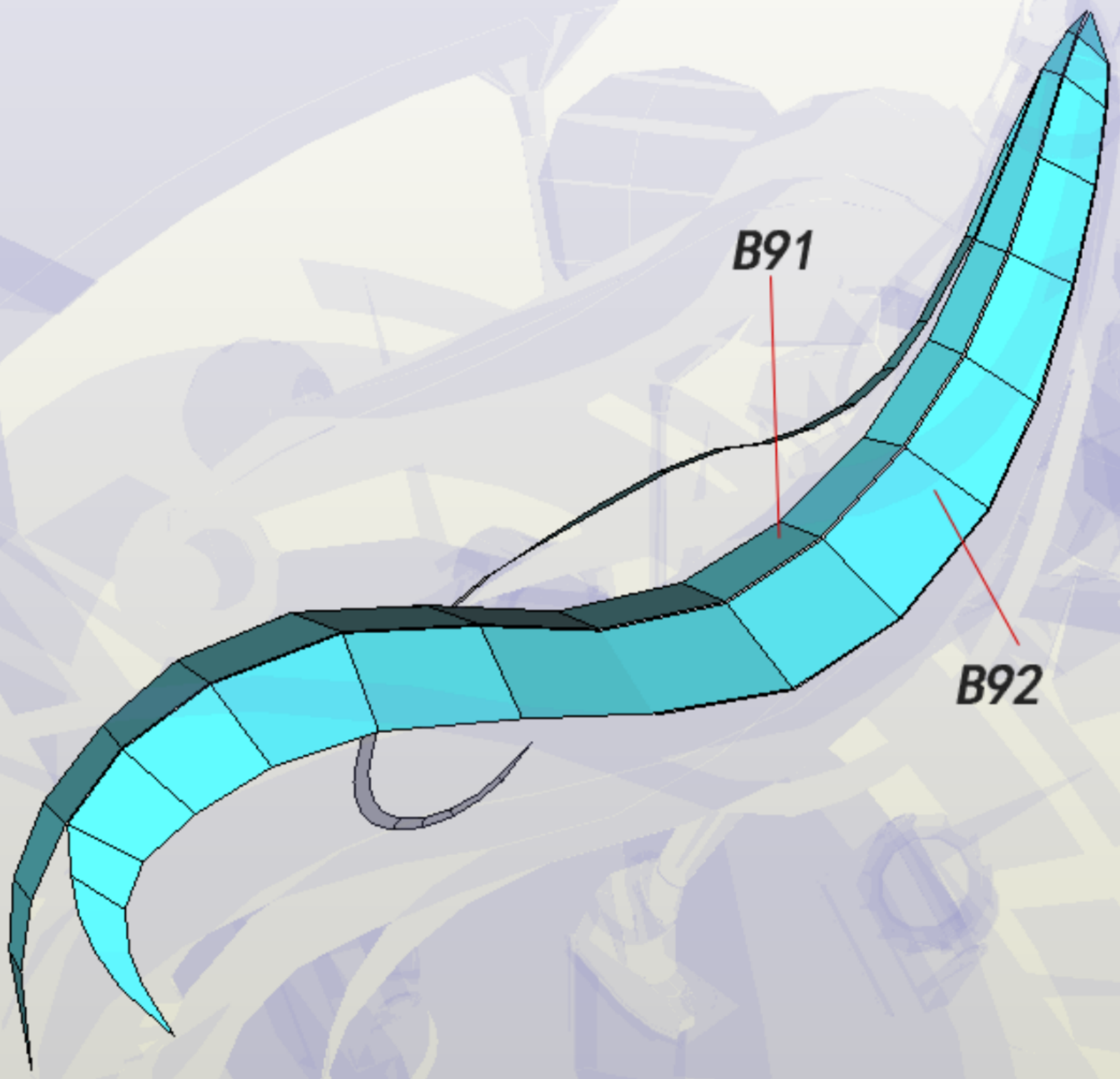

B91

B92

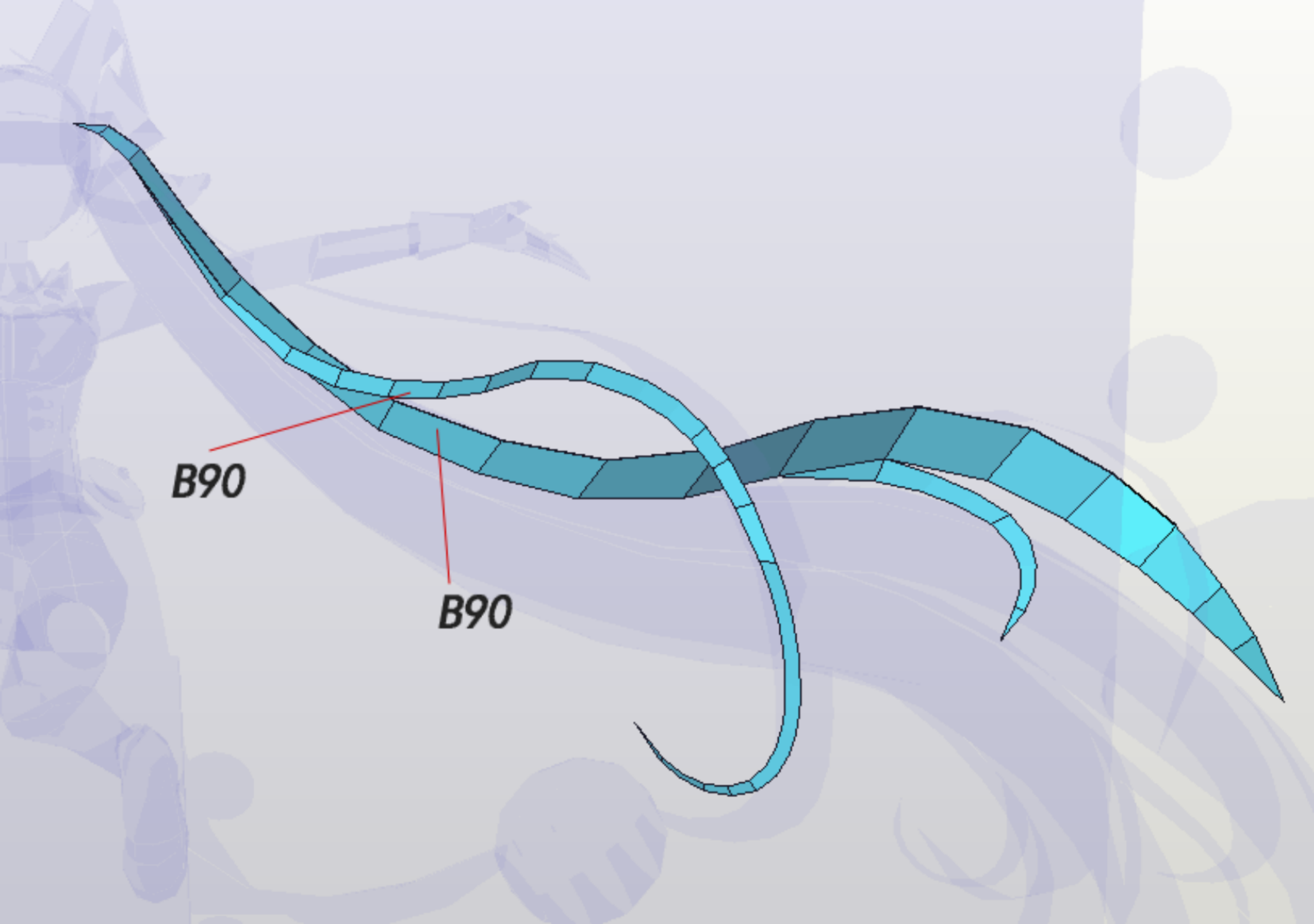

B90

B90

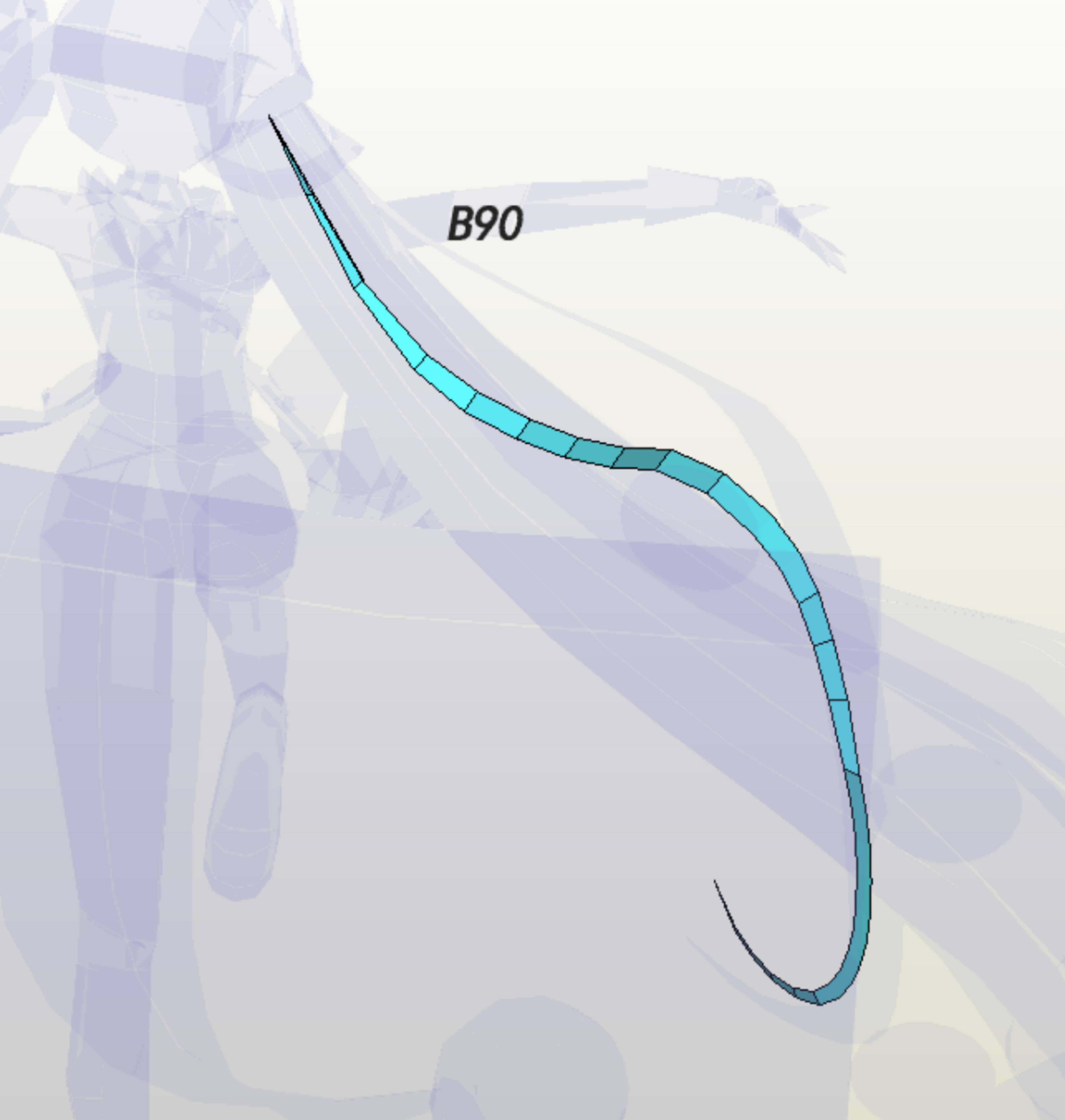

B90

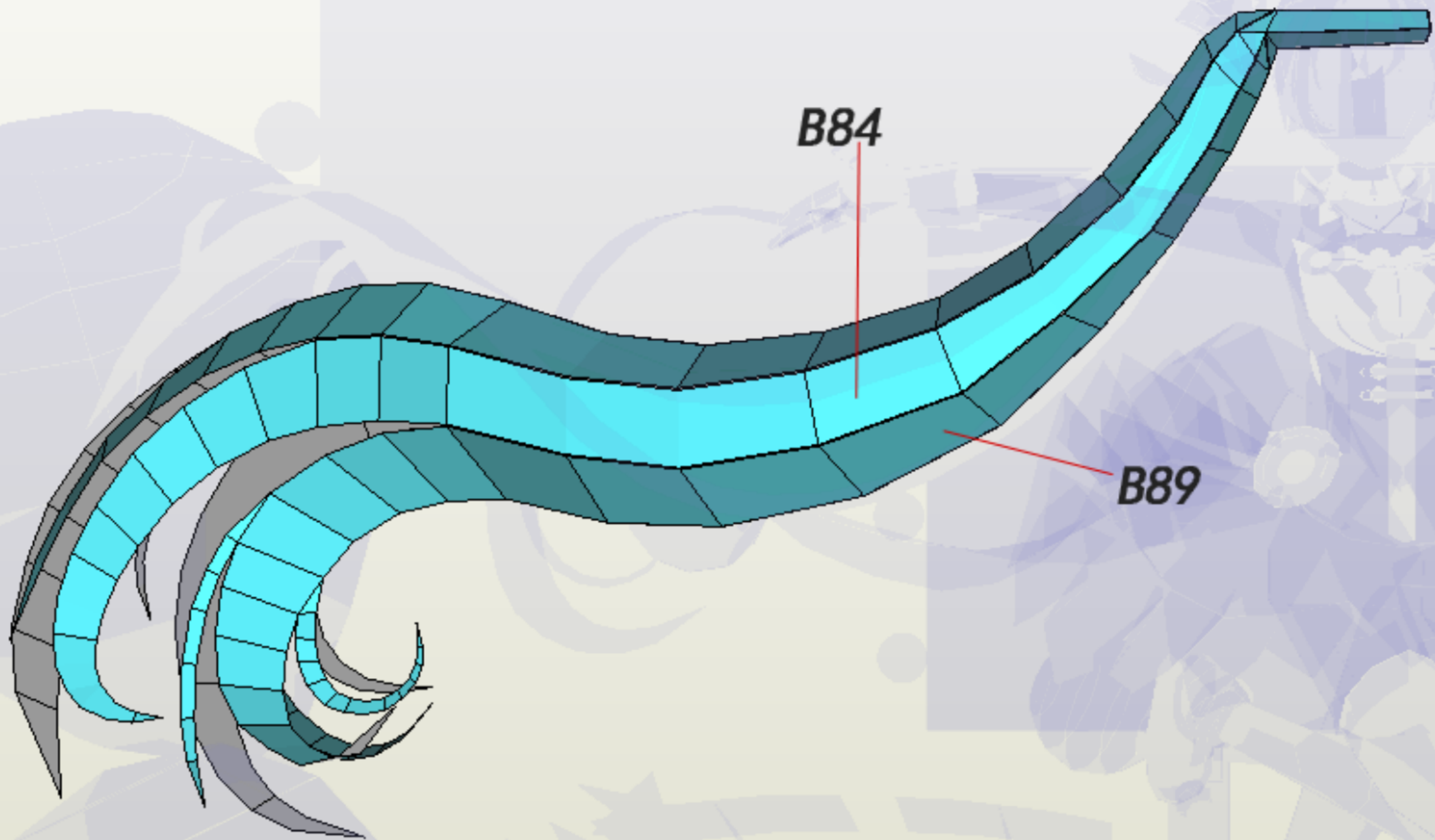

B84

B89

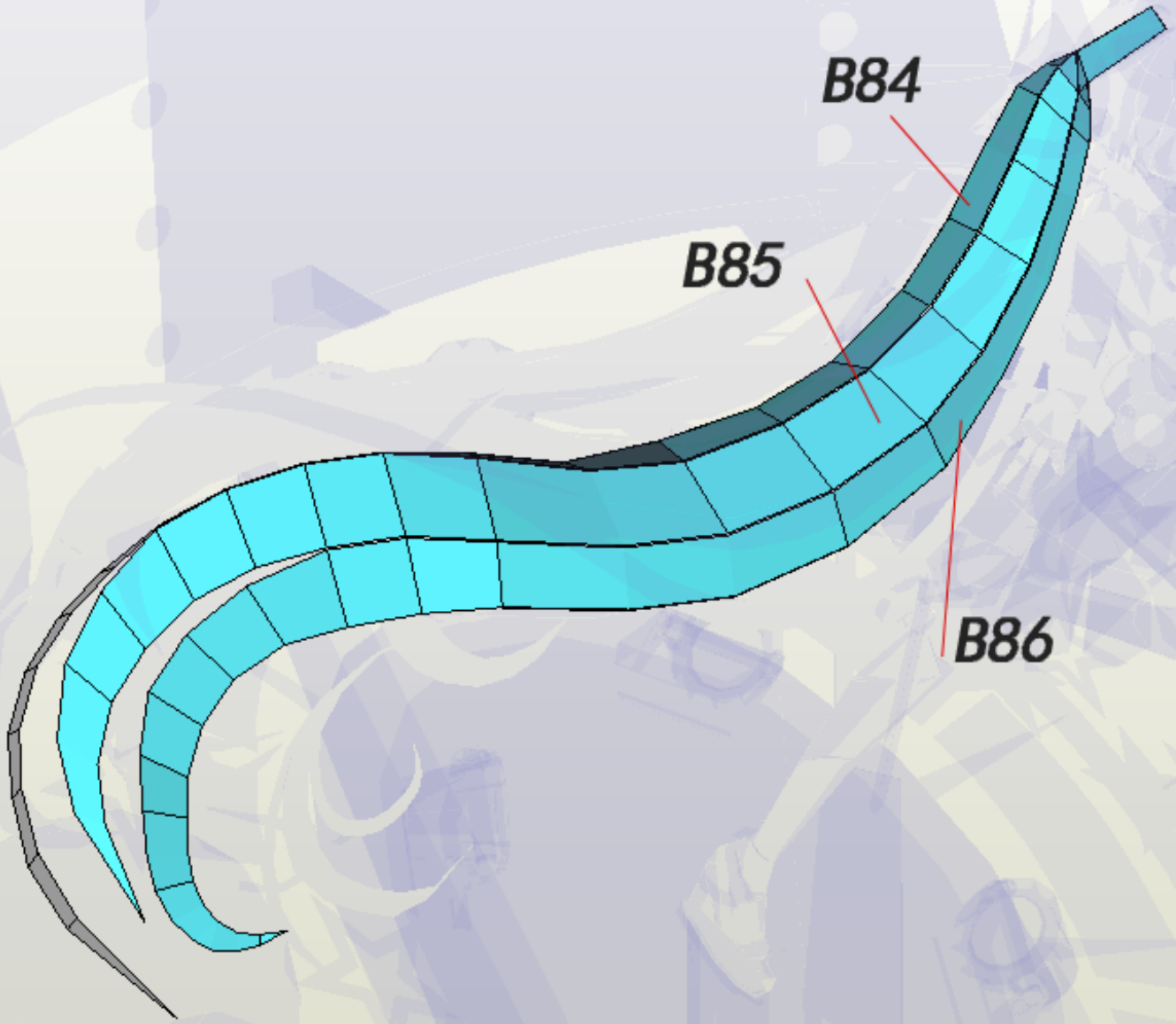

B84

B85

B86

B84

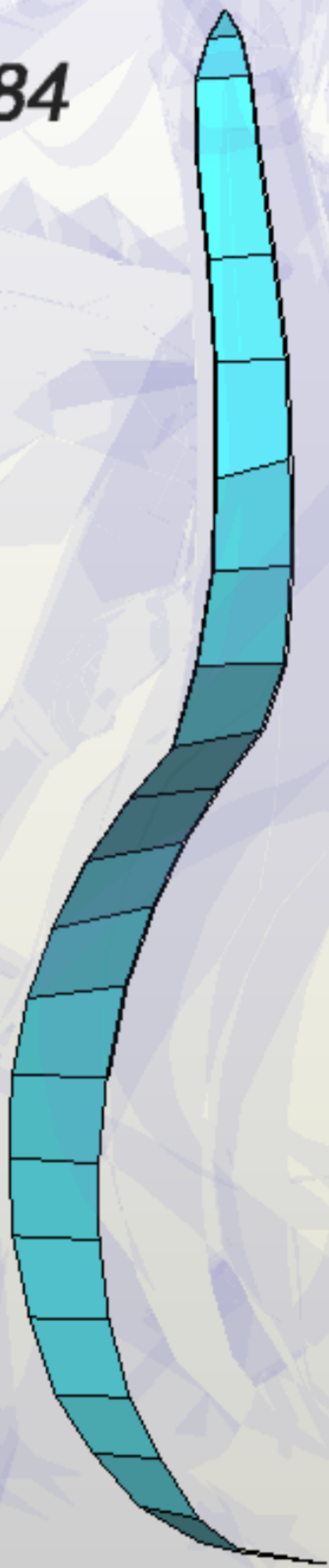



B74



前刘海沾B73上面

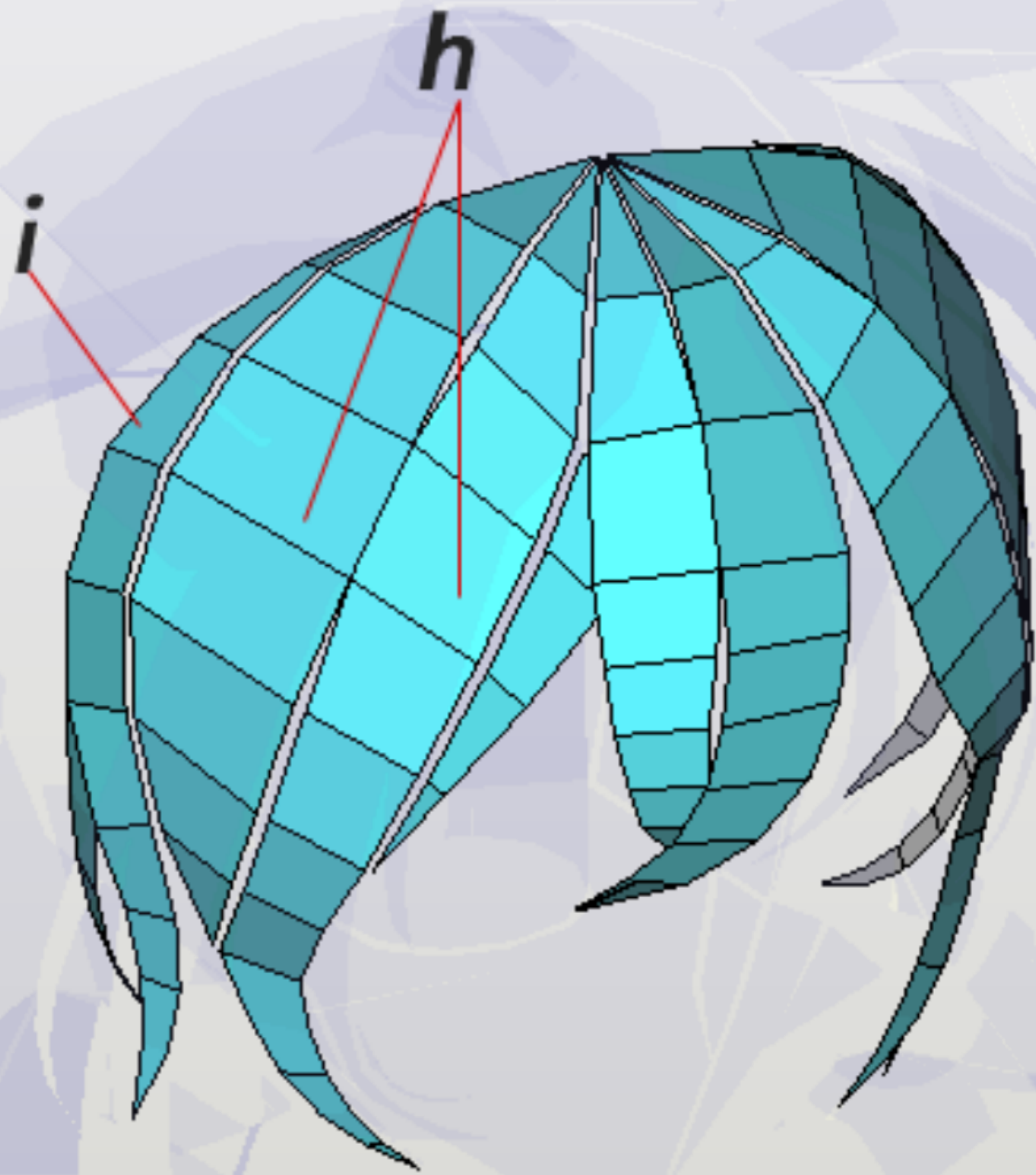

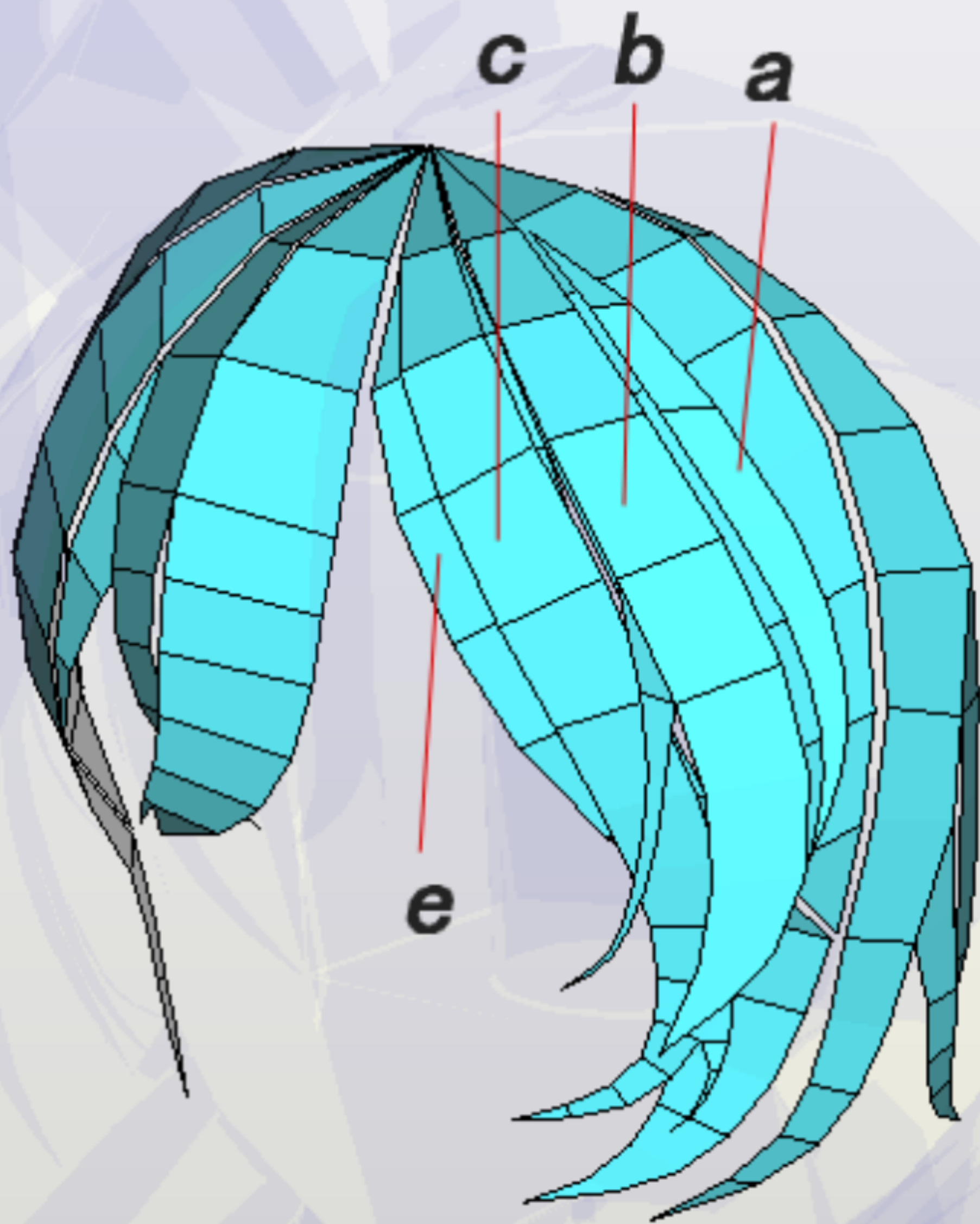

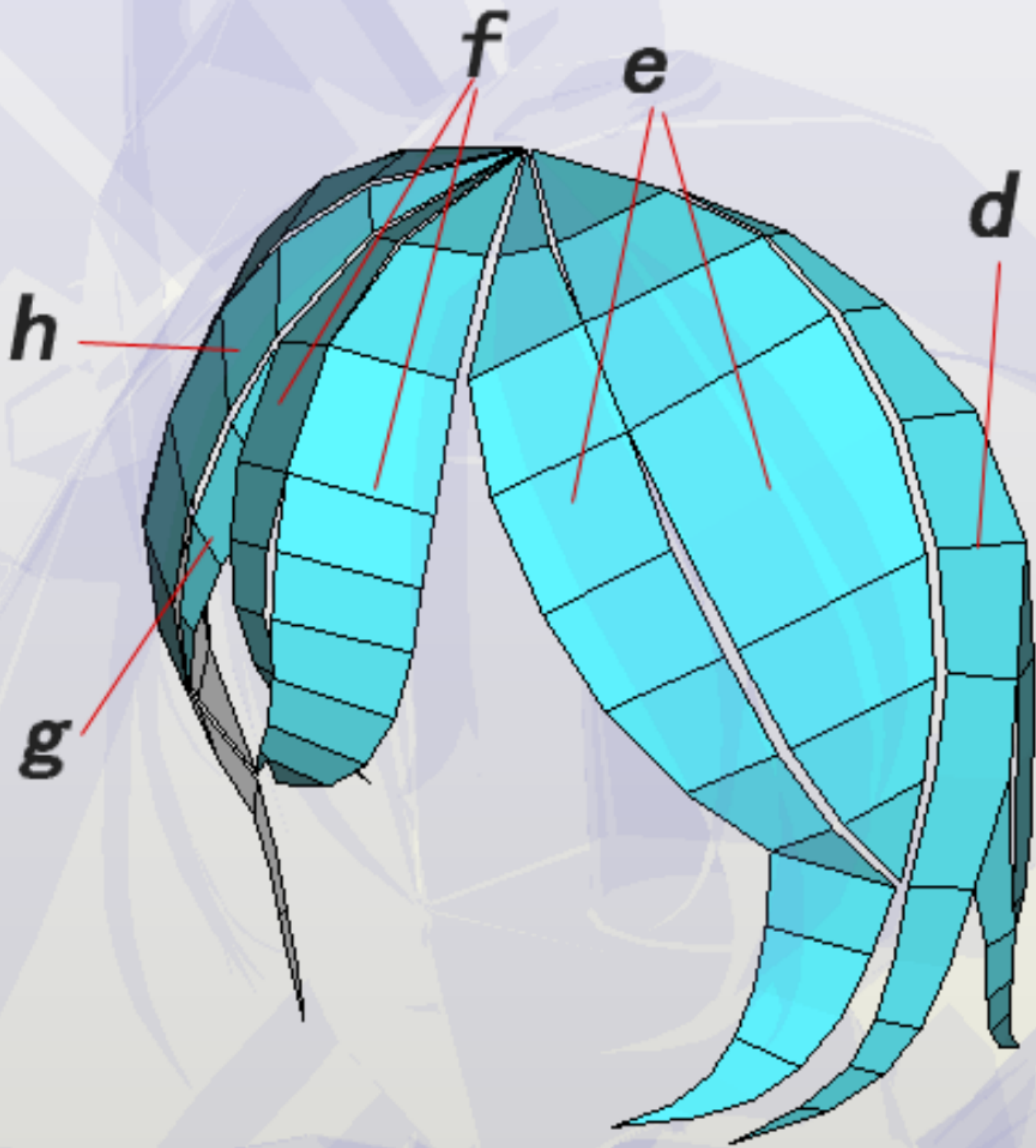

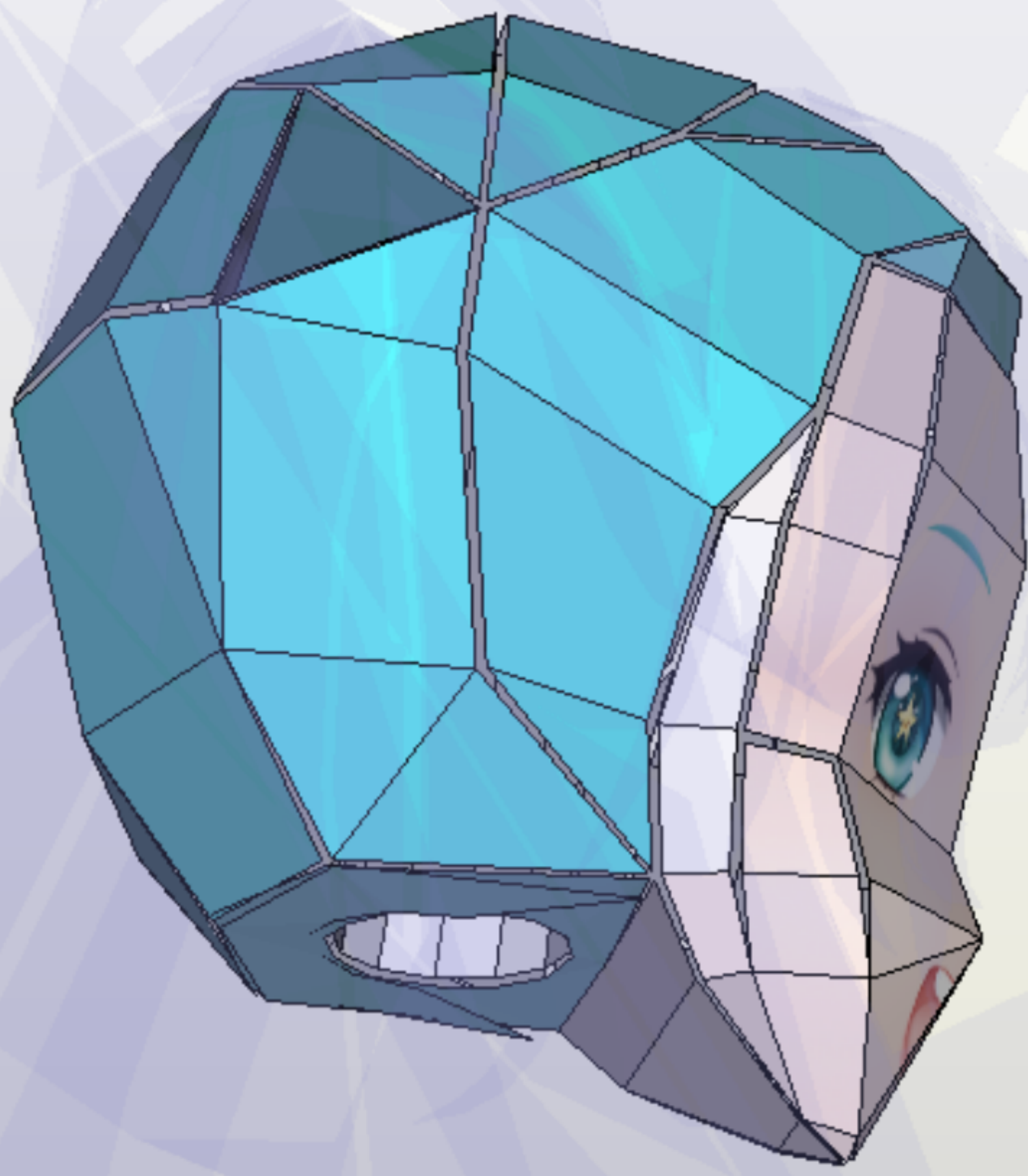

B80

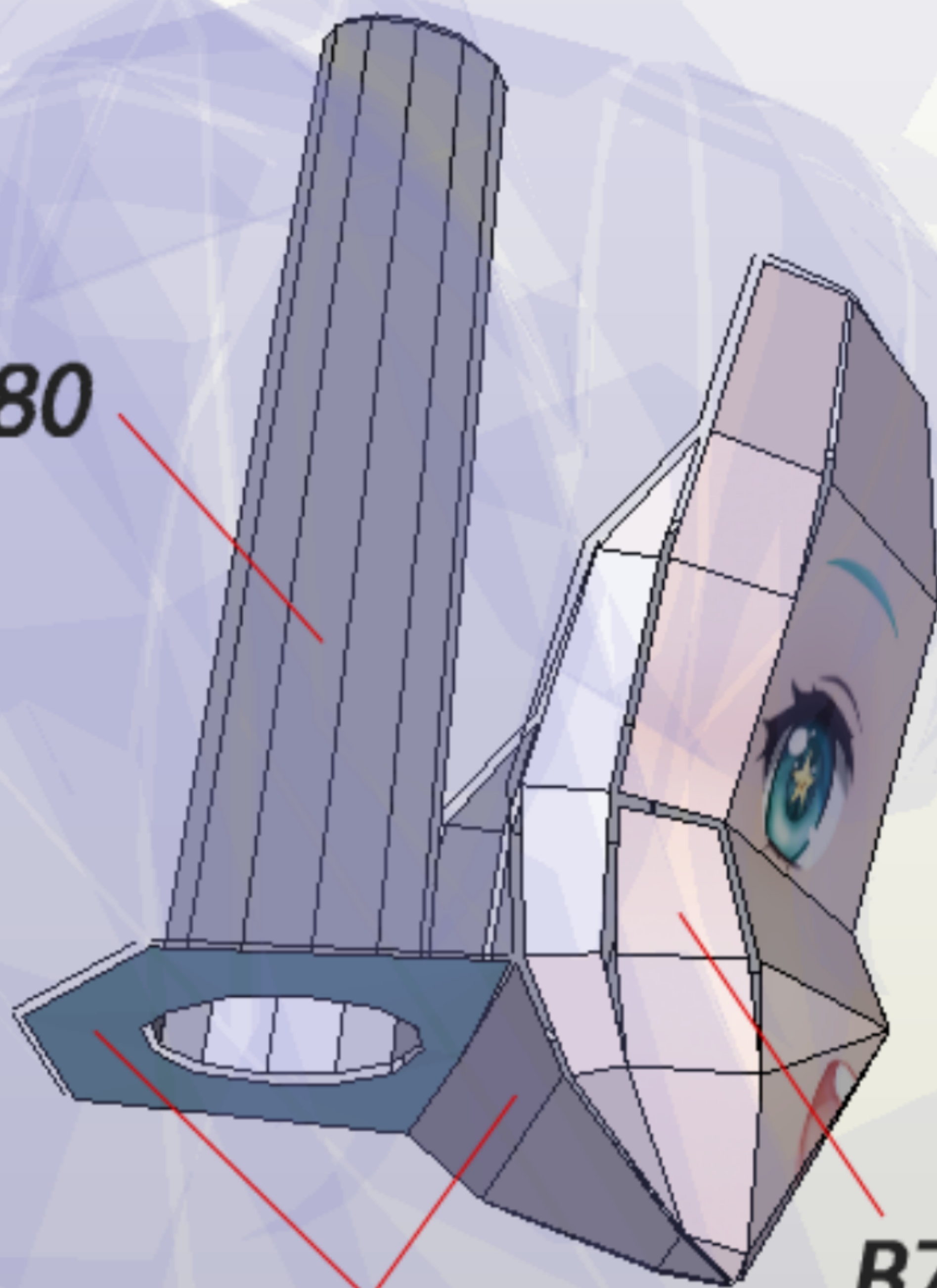

B79

B70

B96a

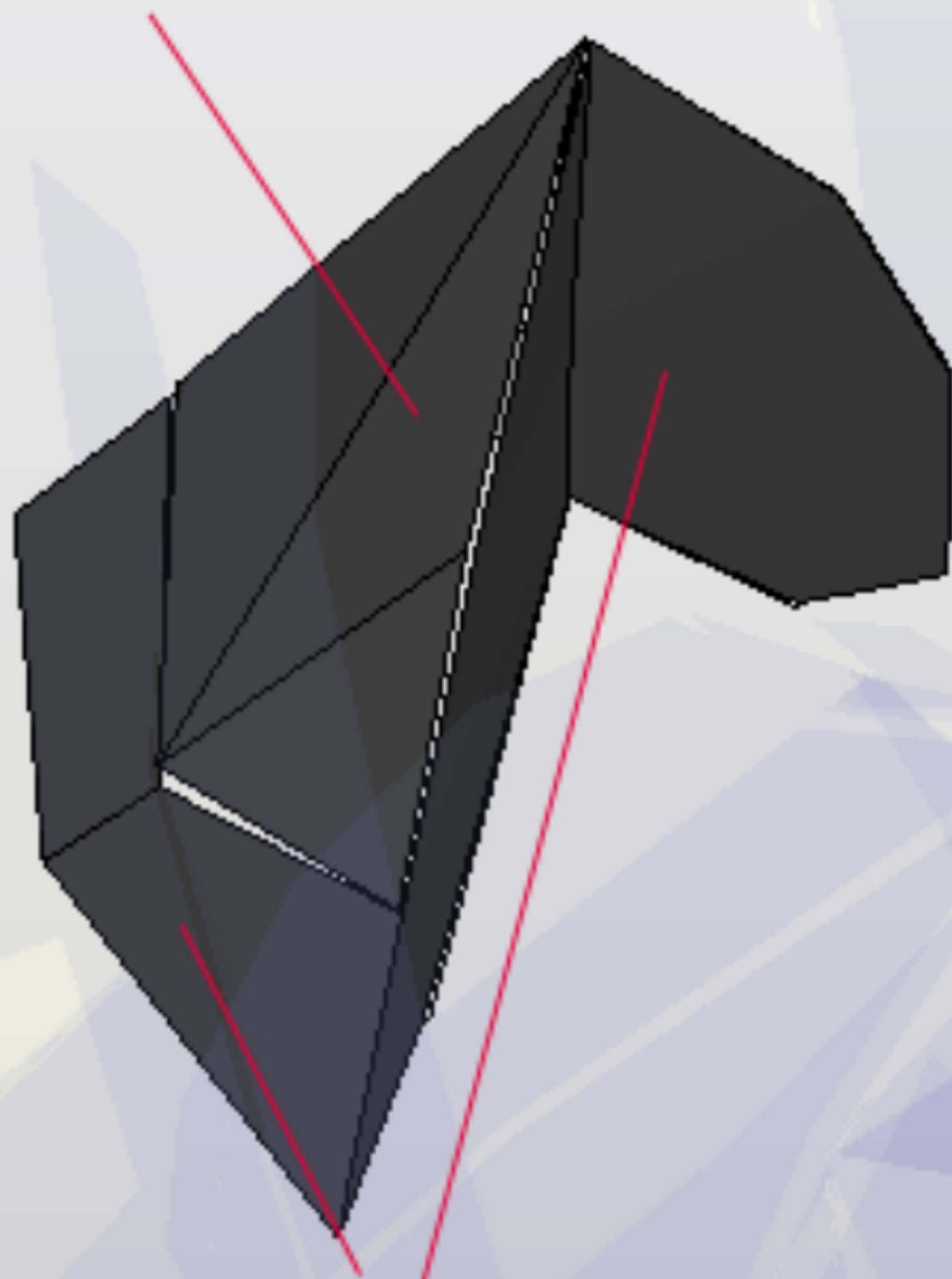

B96

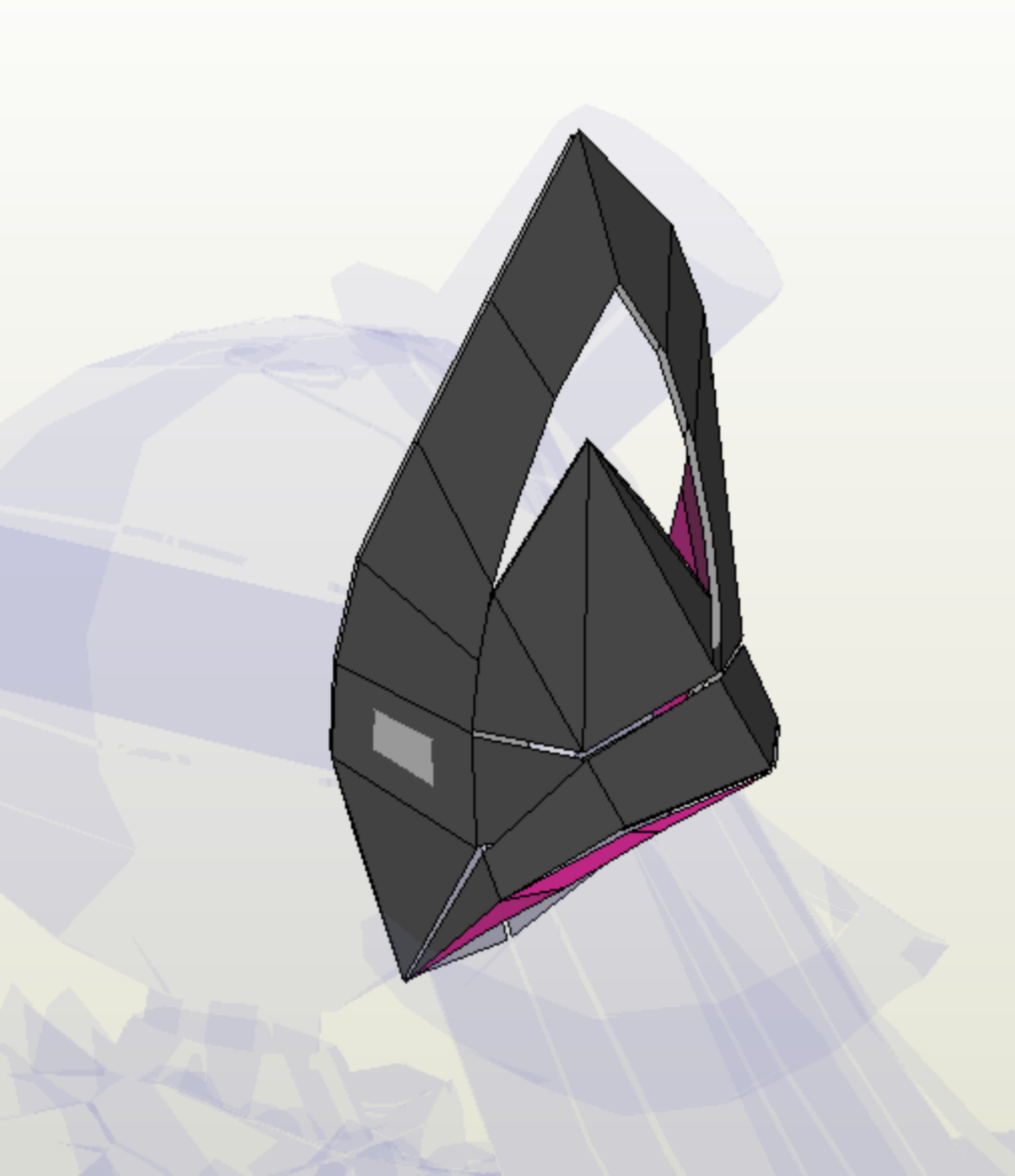

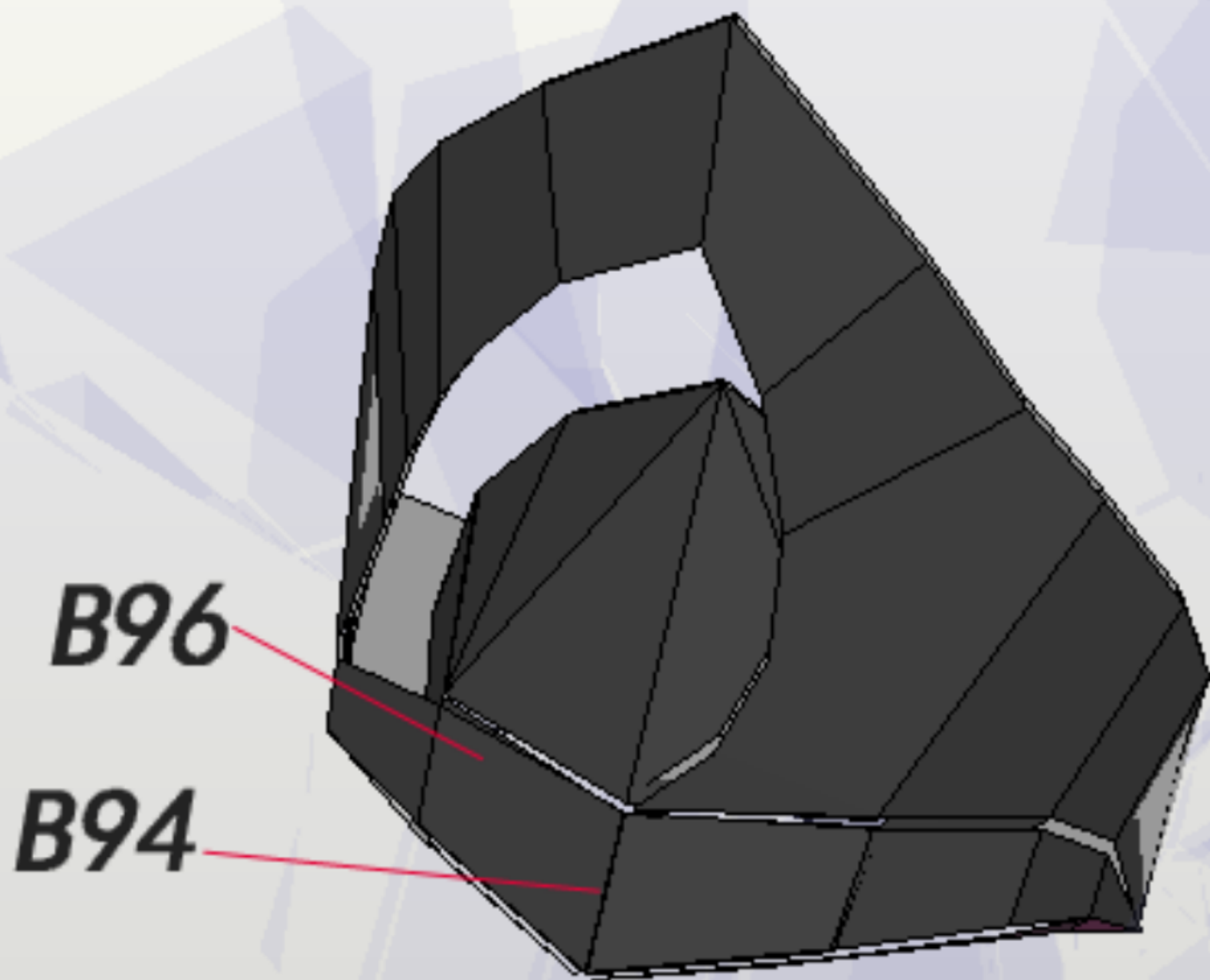

B96

B94

B94 B96重合沾一起

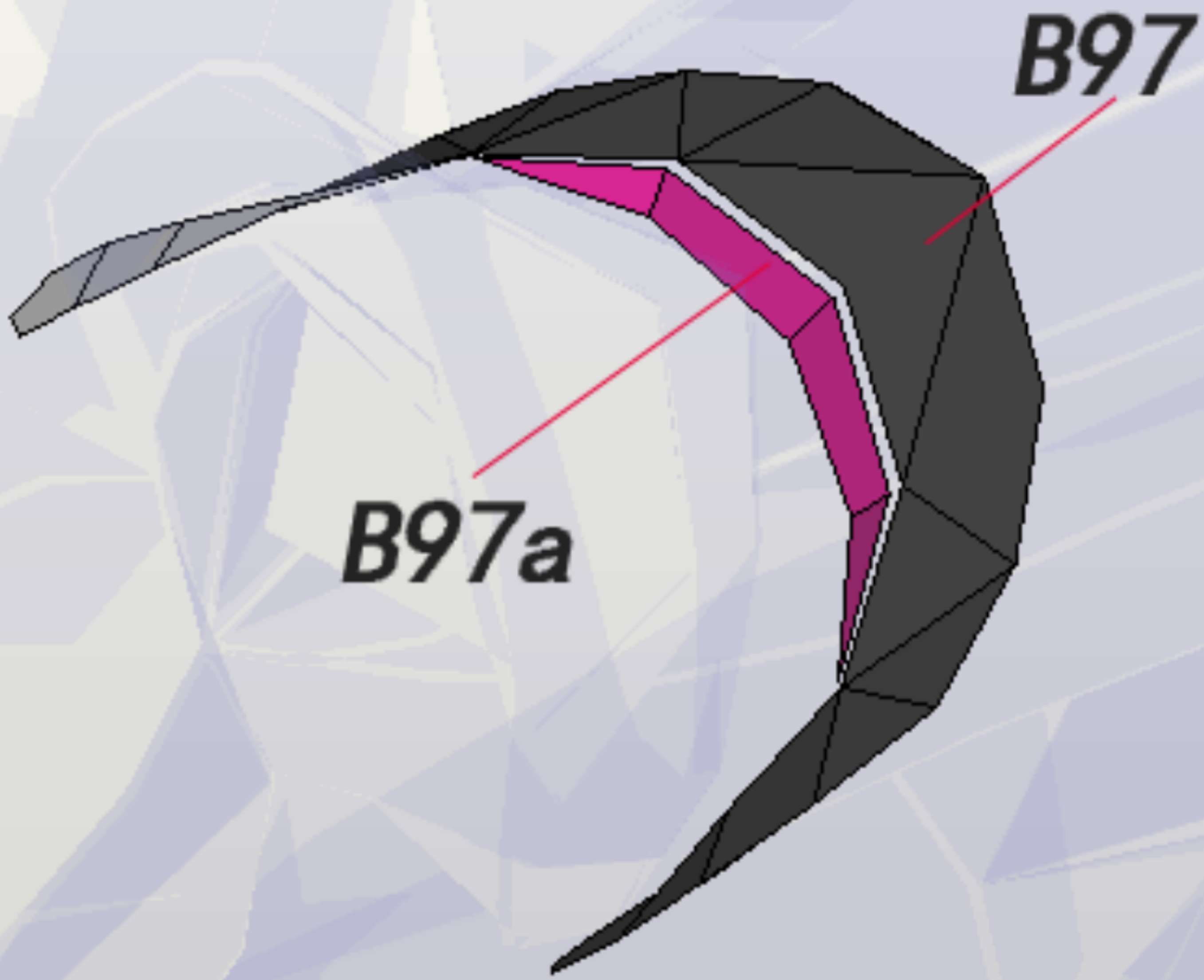

B97

B97a

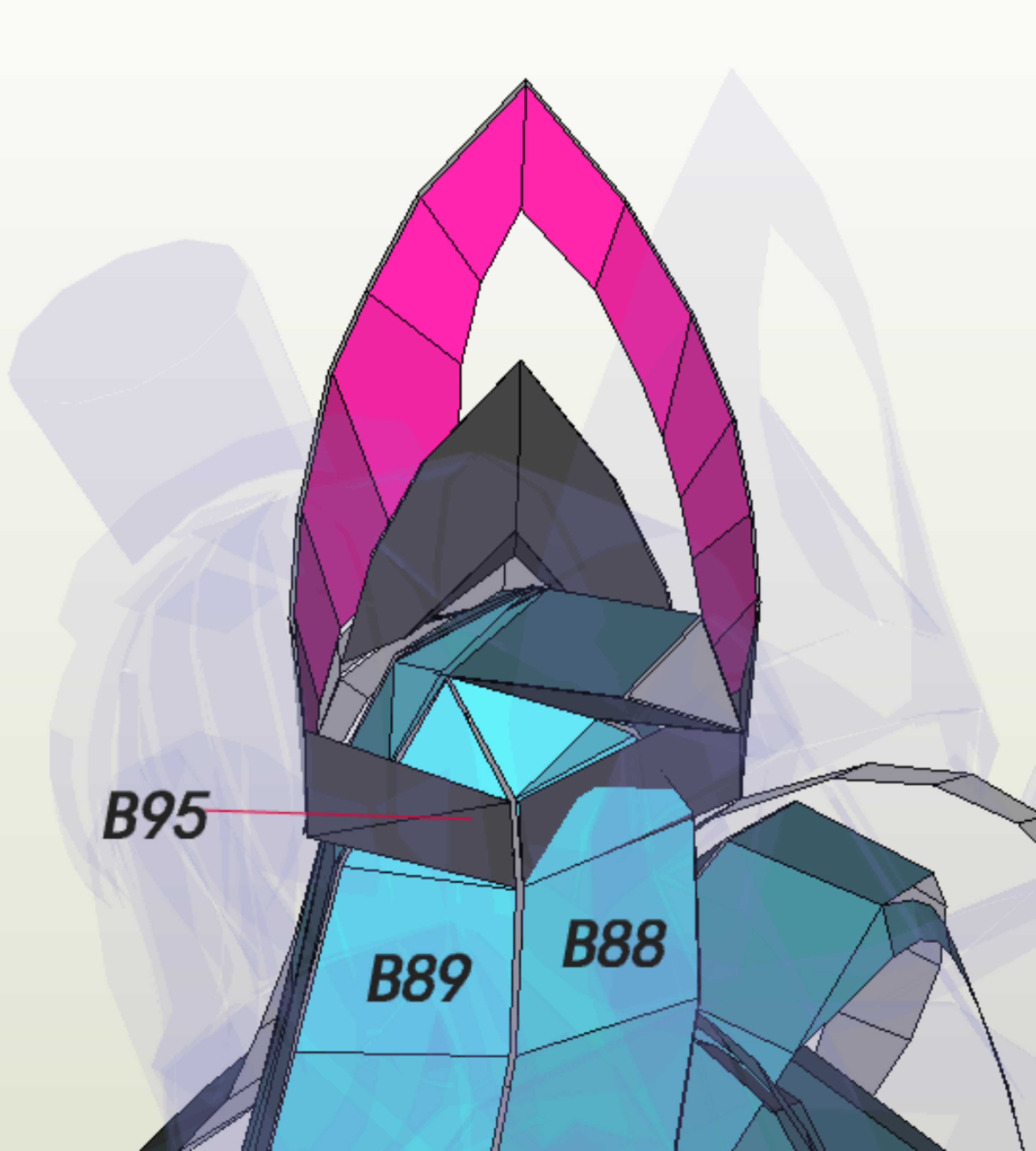

B95

B89

B88

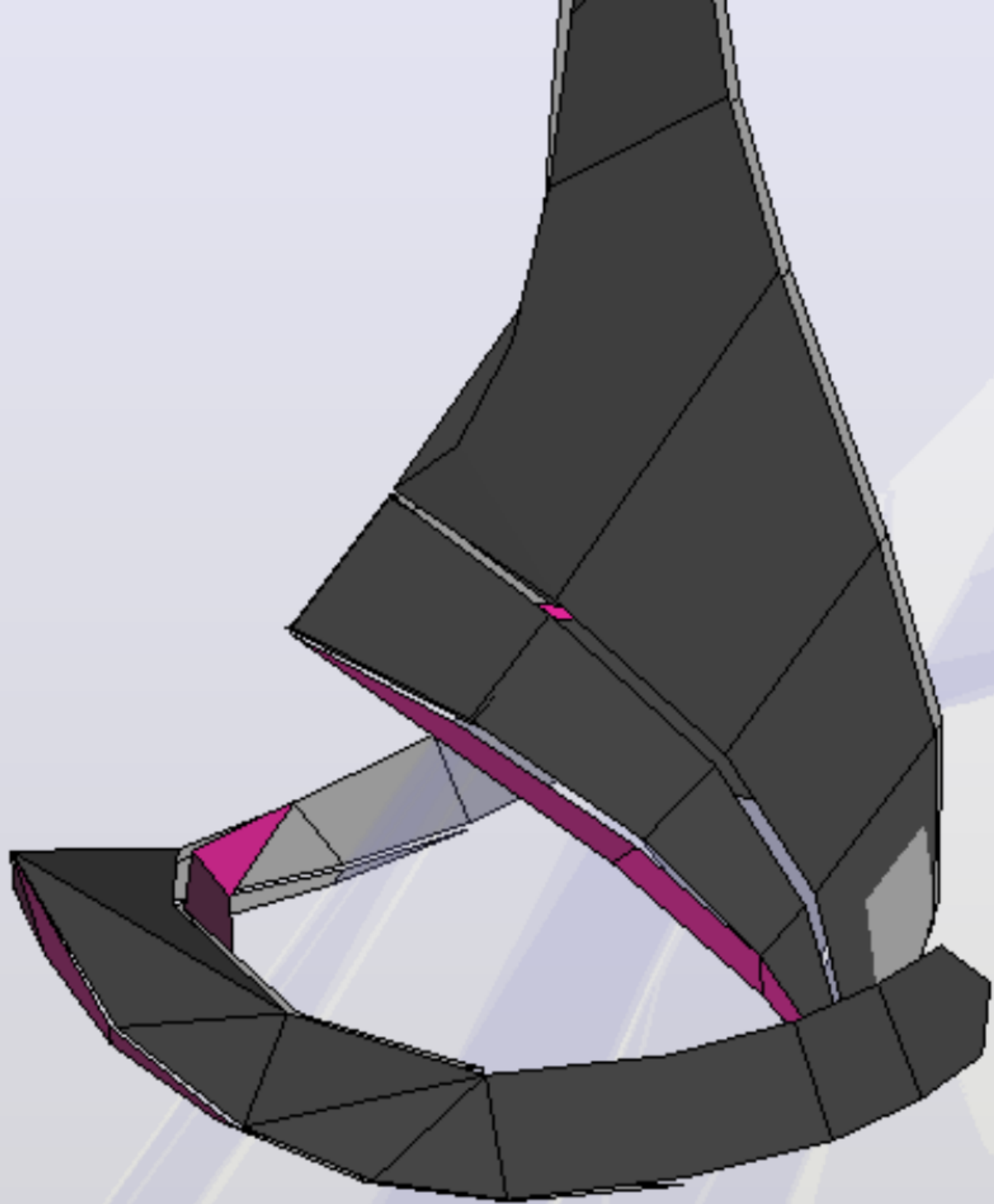

B98

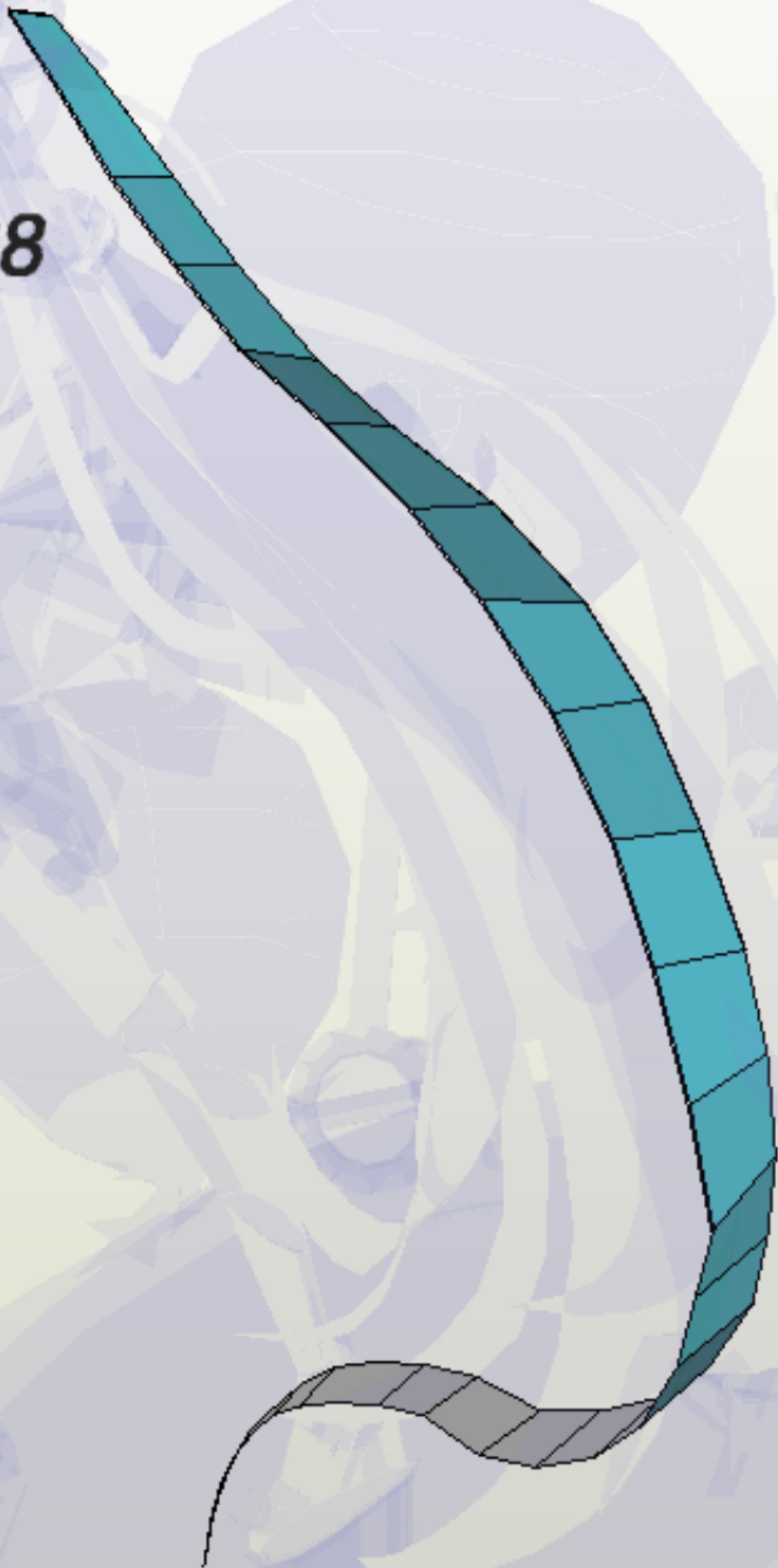

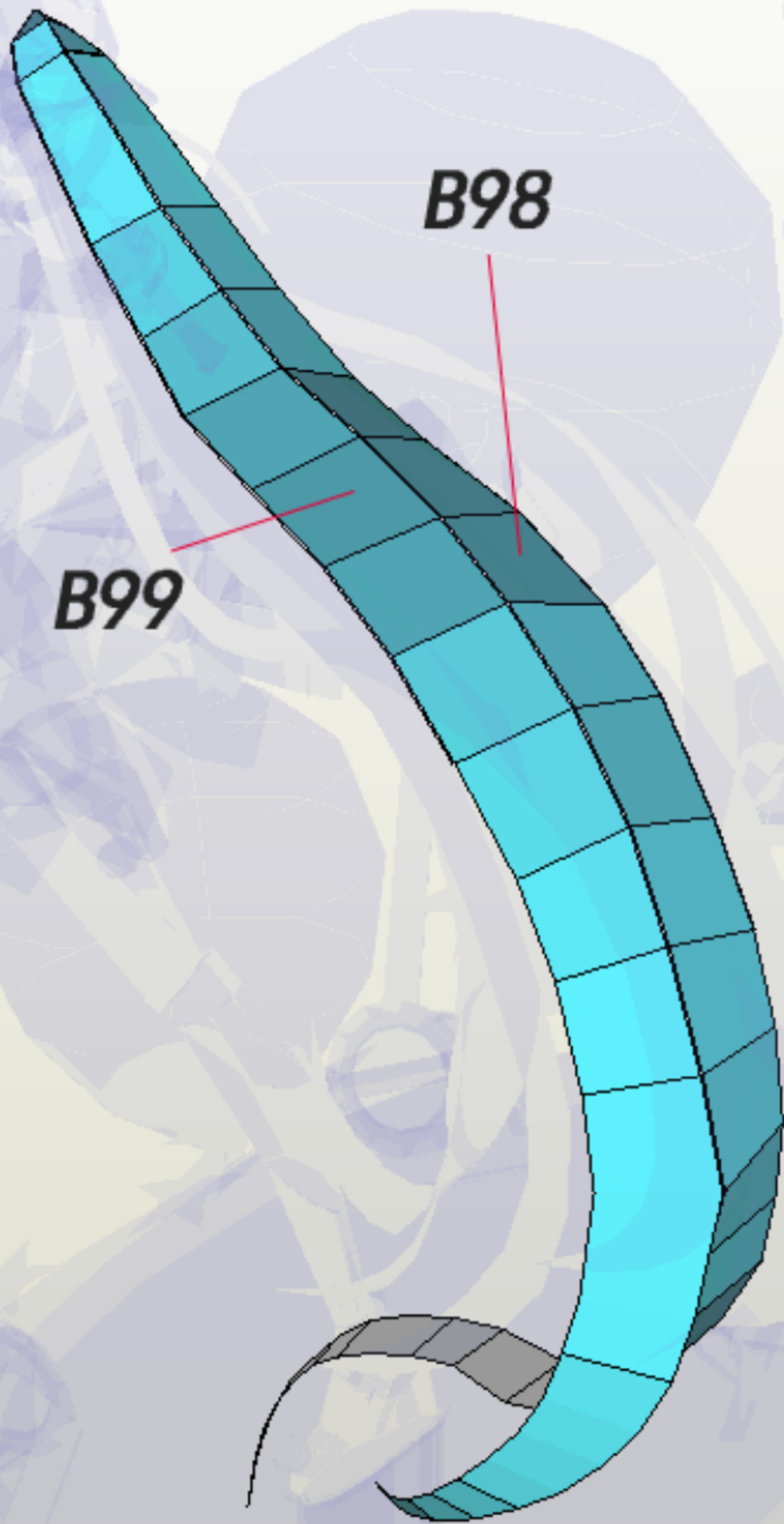

B98

B99

B105

B104

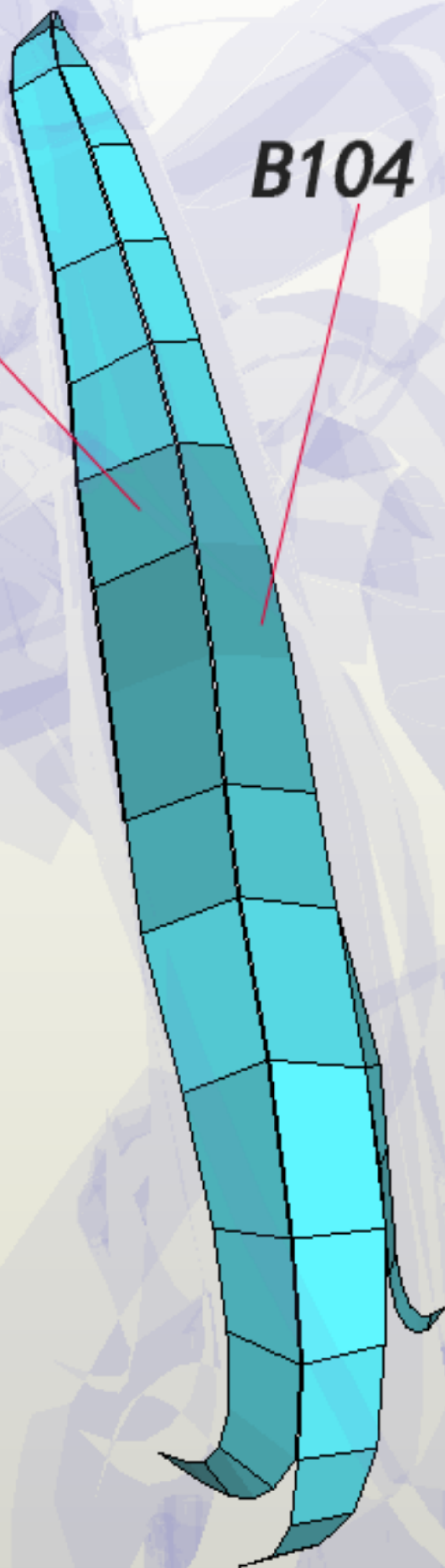

B104

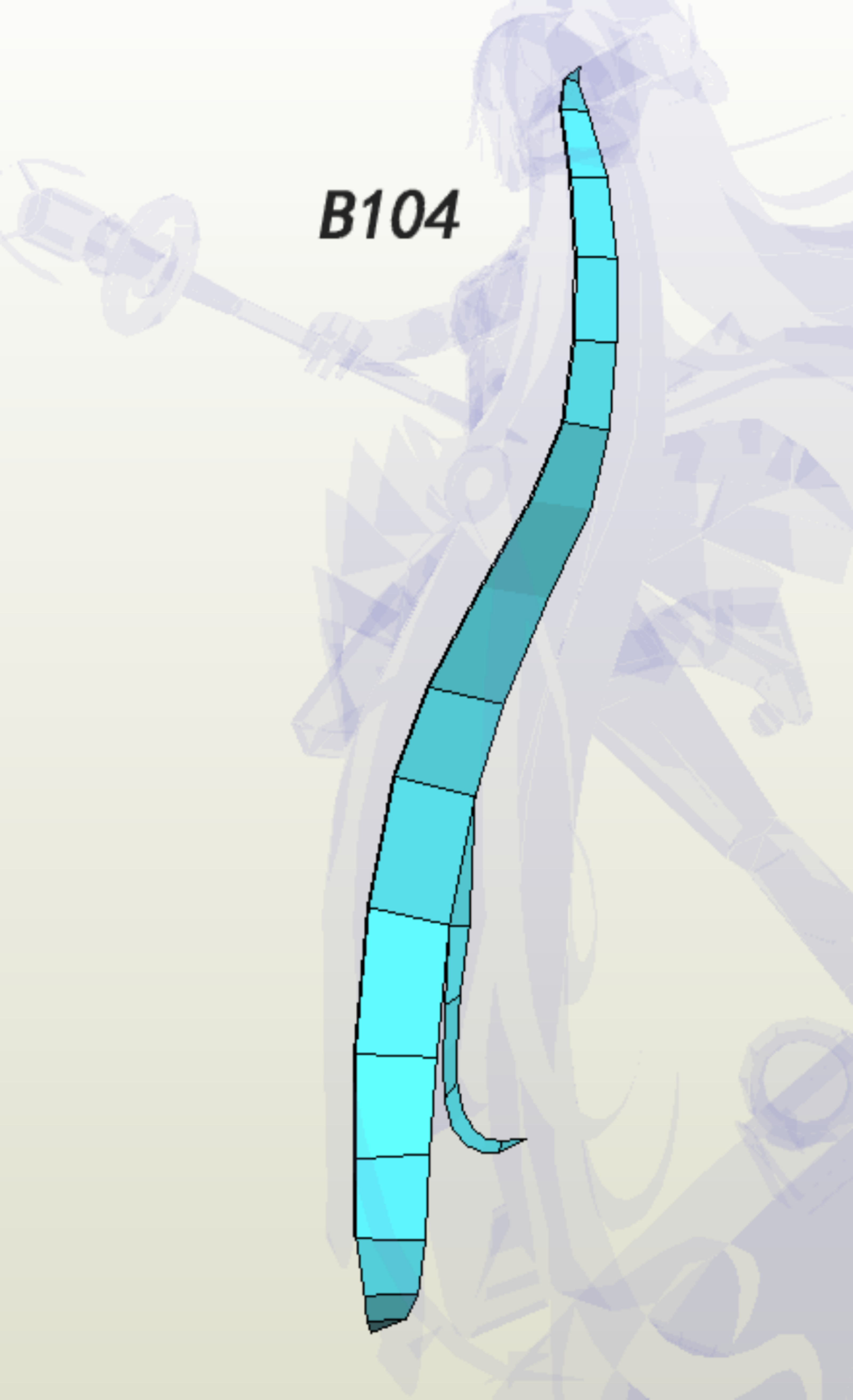

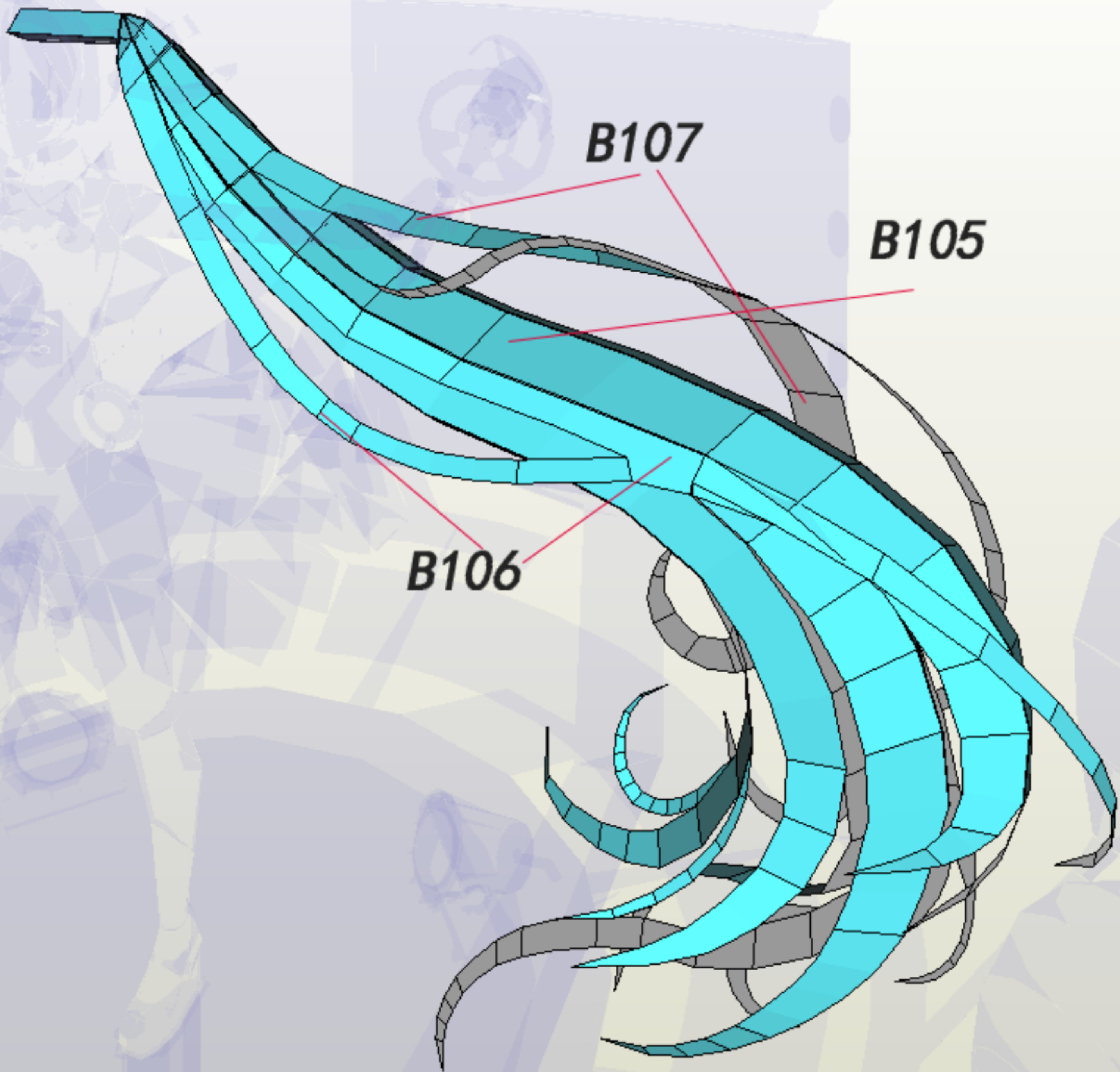

B107

B105

B106

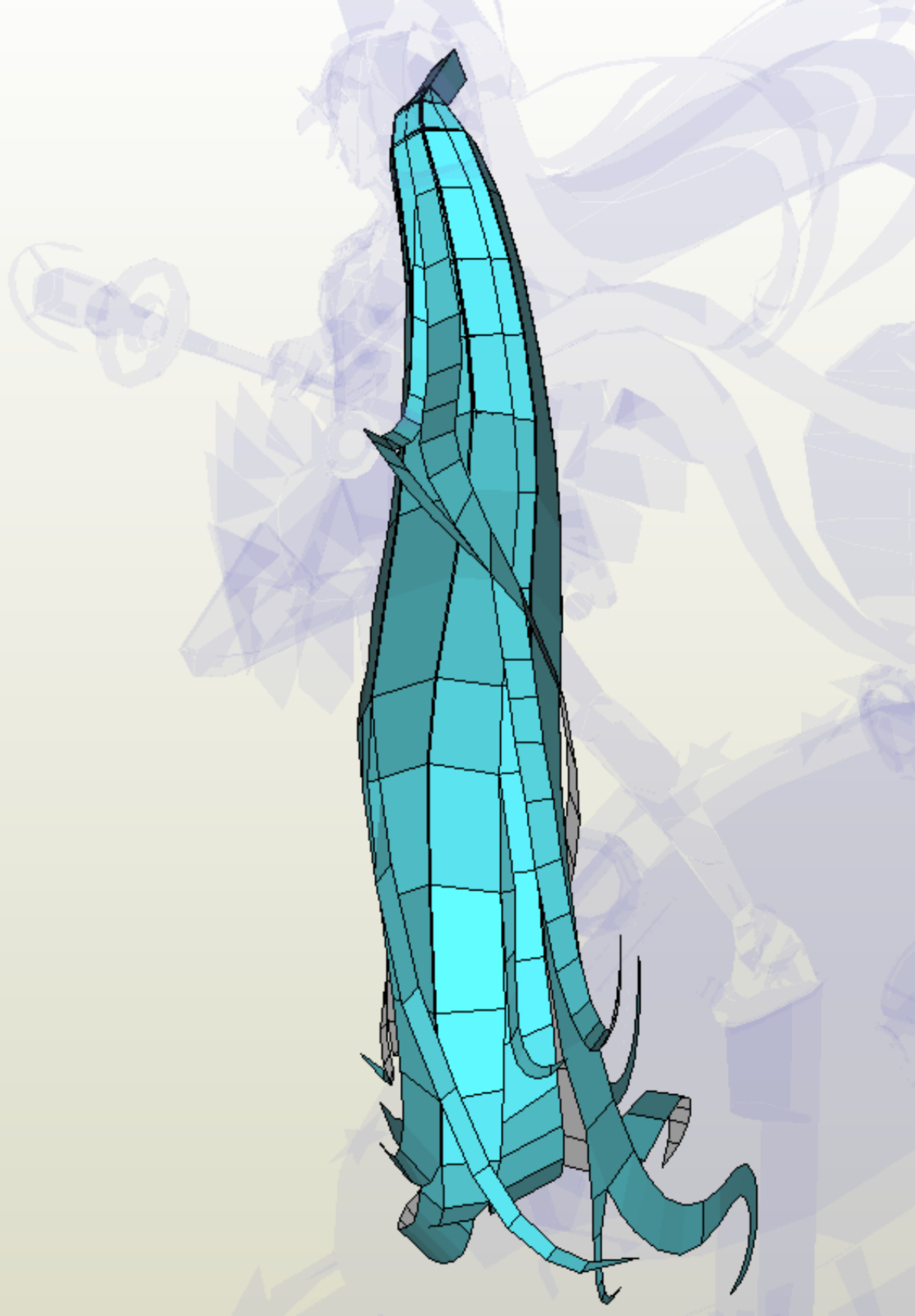



A74

A69c

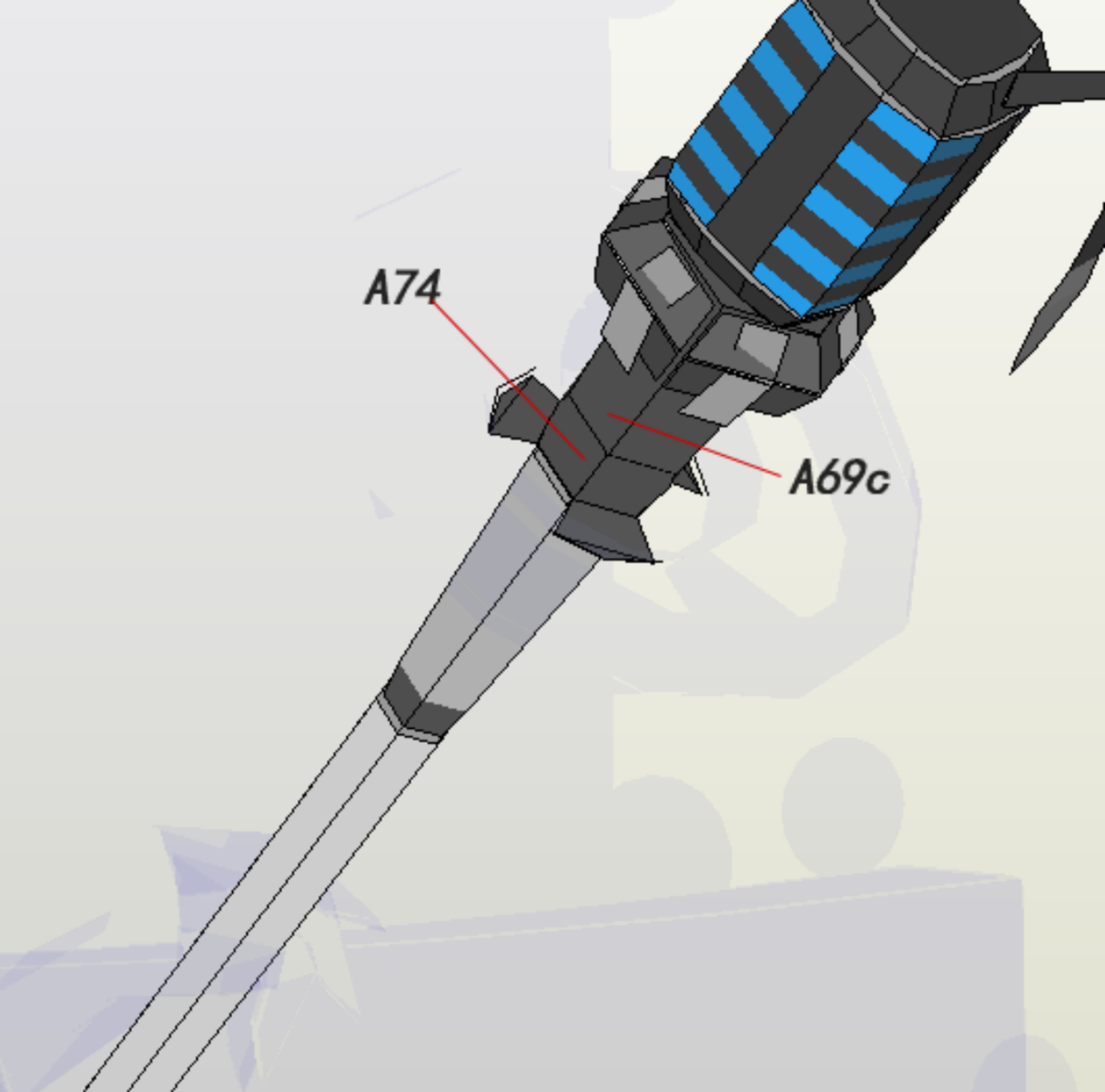

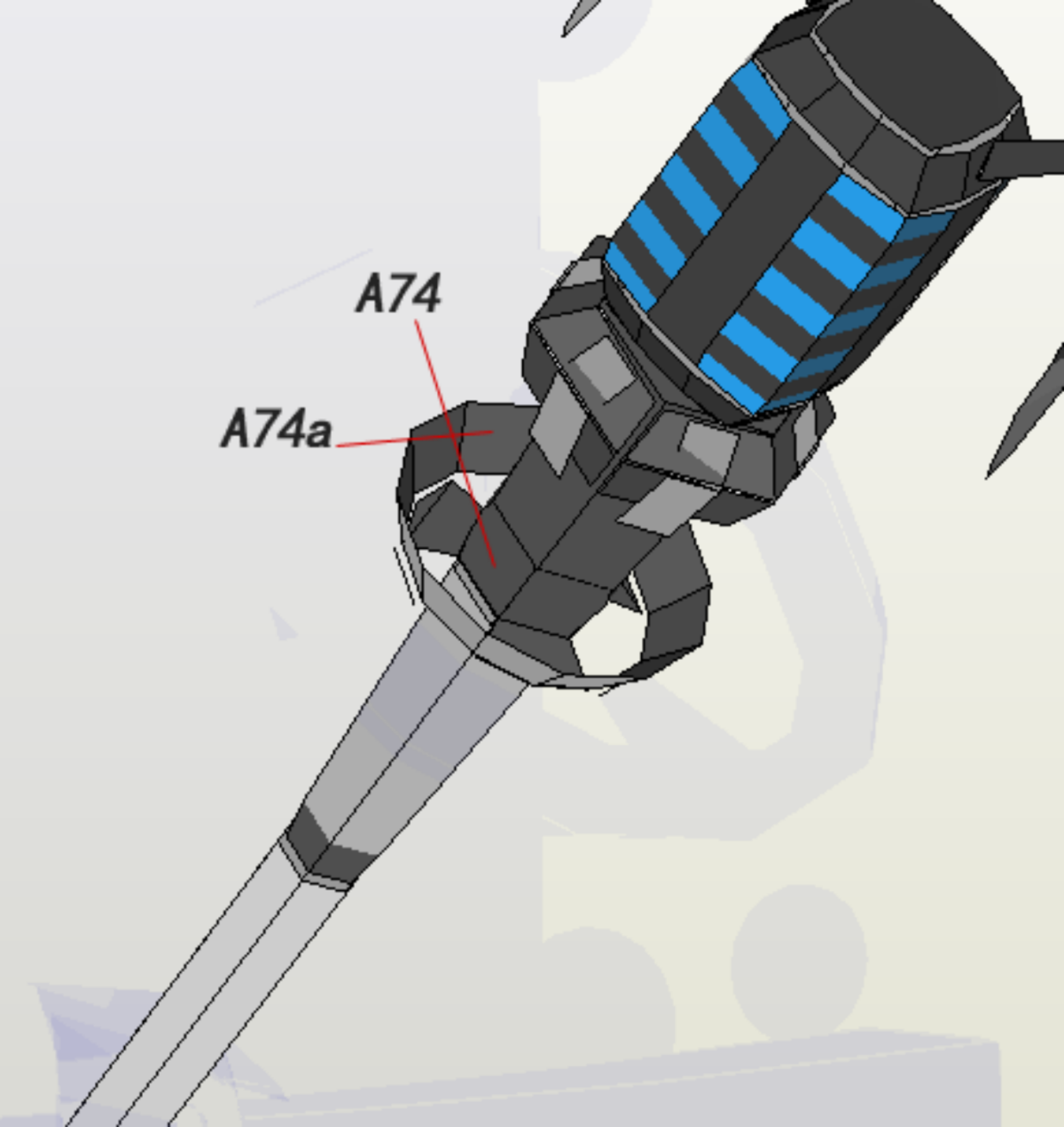

A74

A74a

A74b

A74a

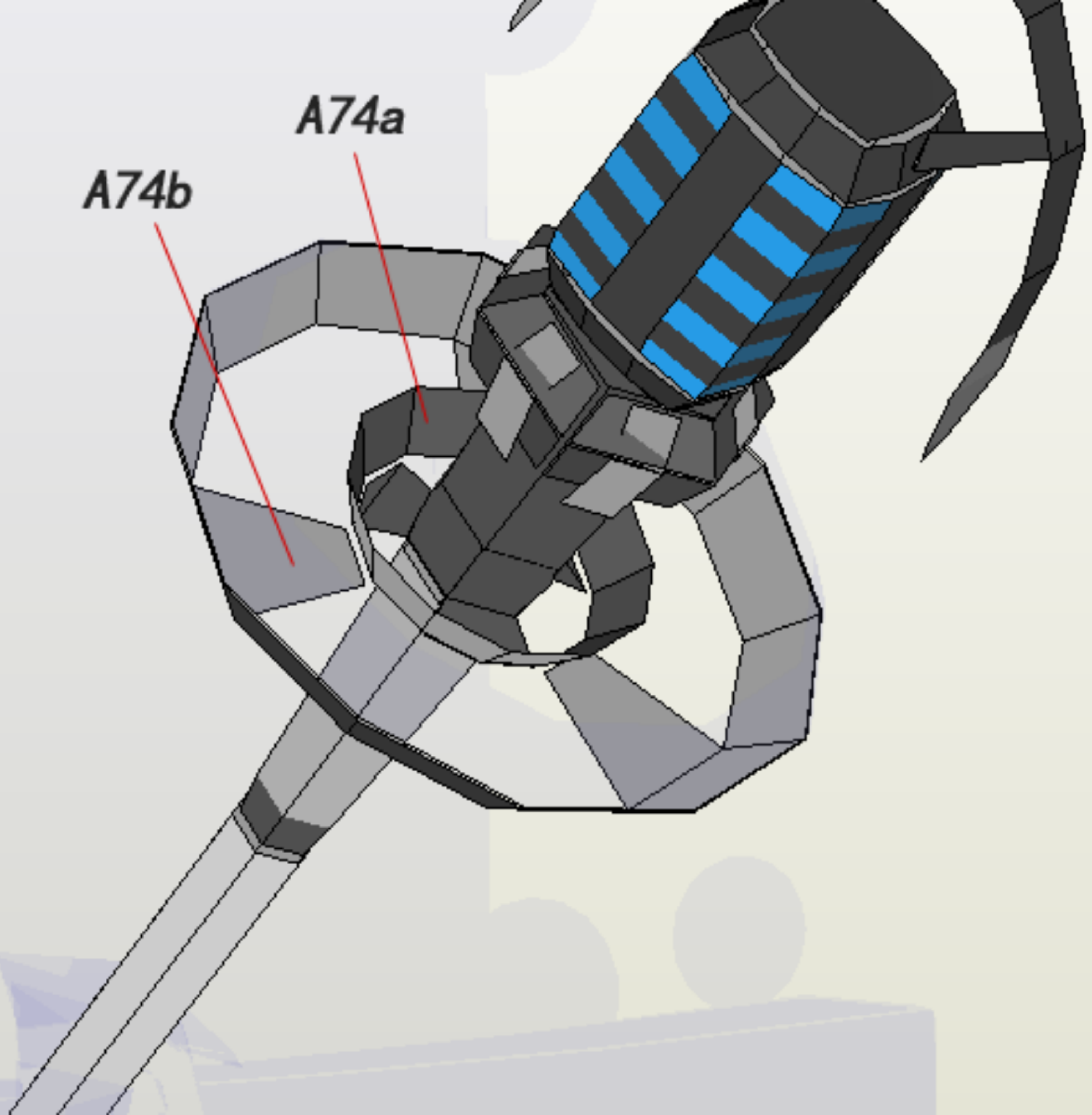

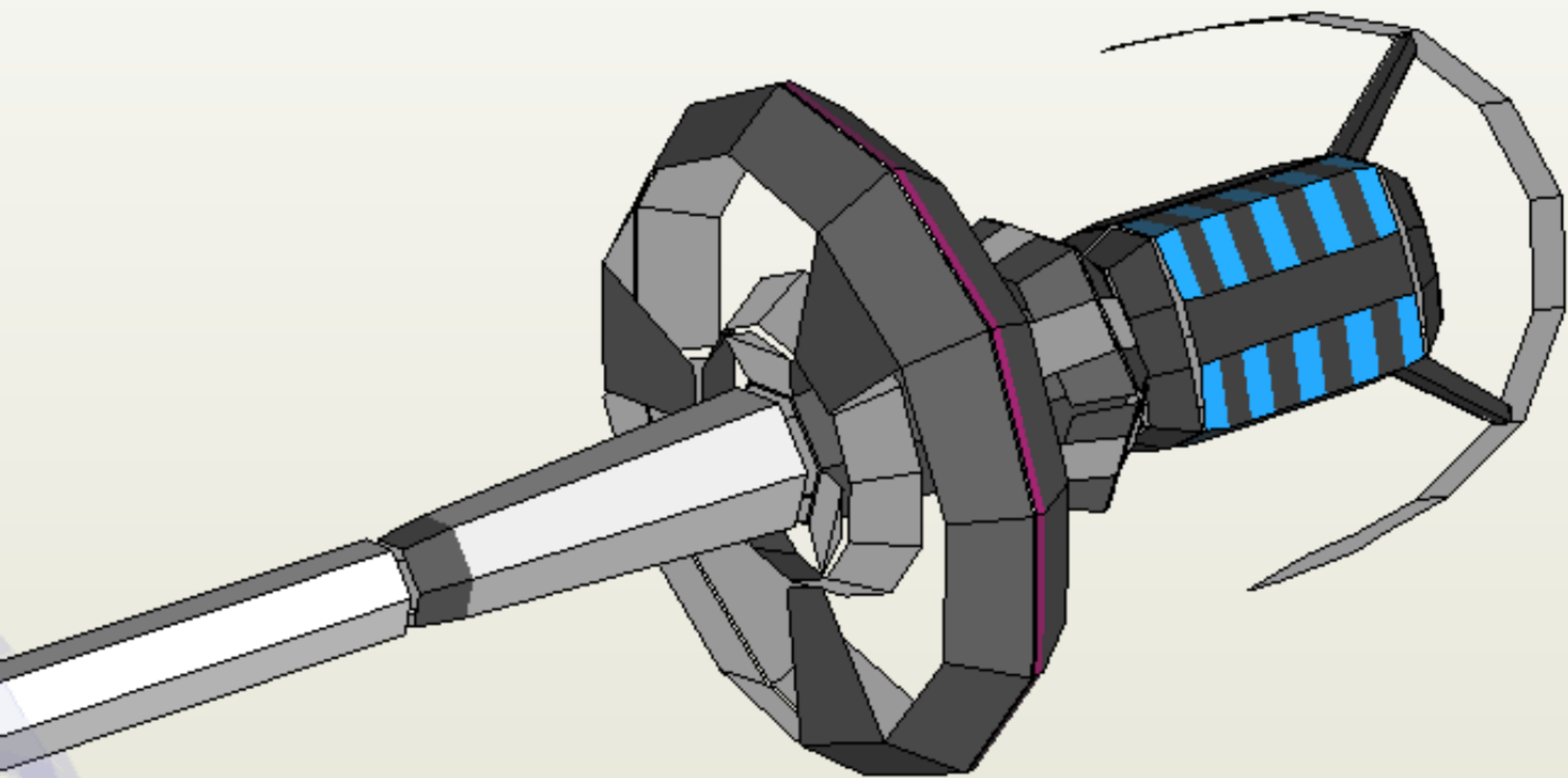

A74c

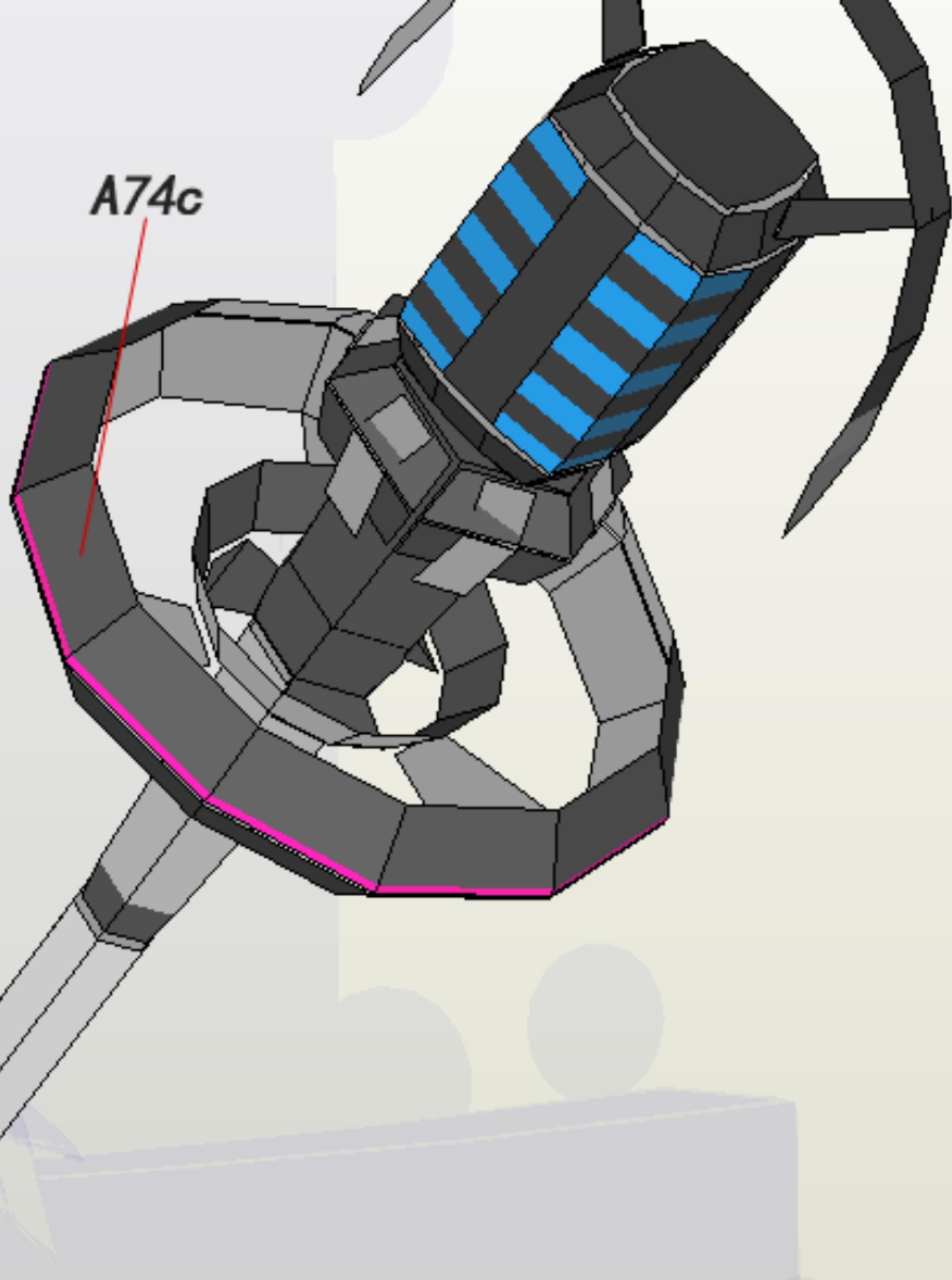

B75

B77

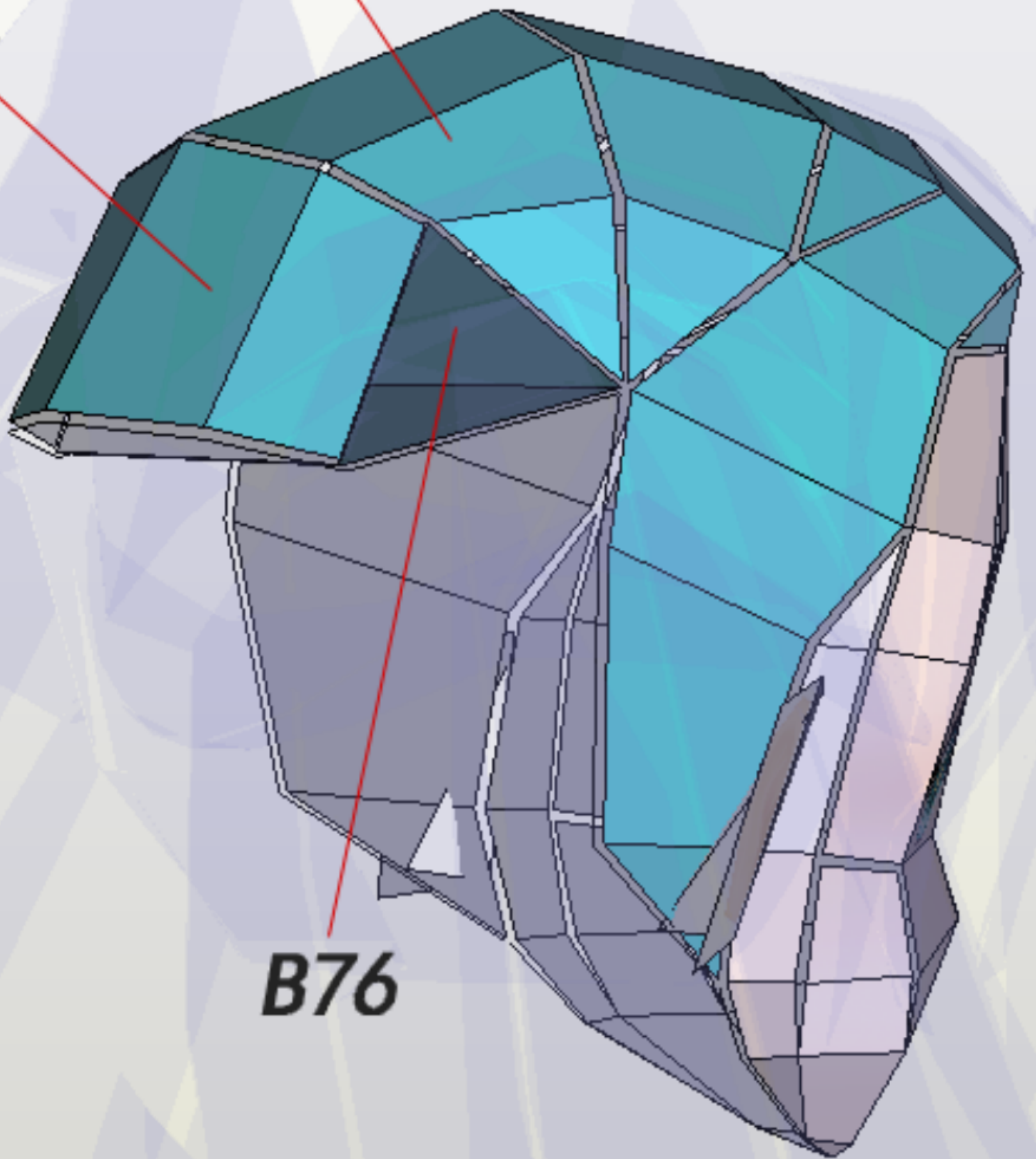

B76

脸部制作教程在新手必读中

B70

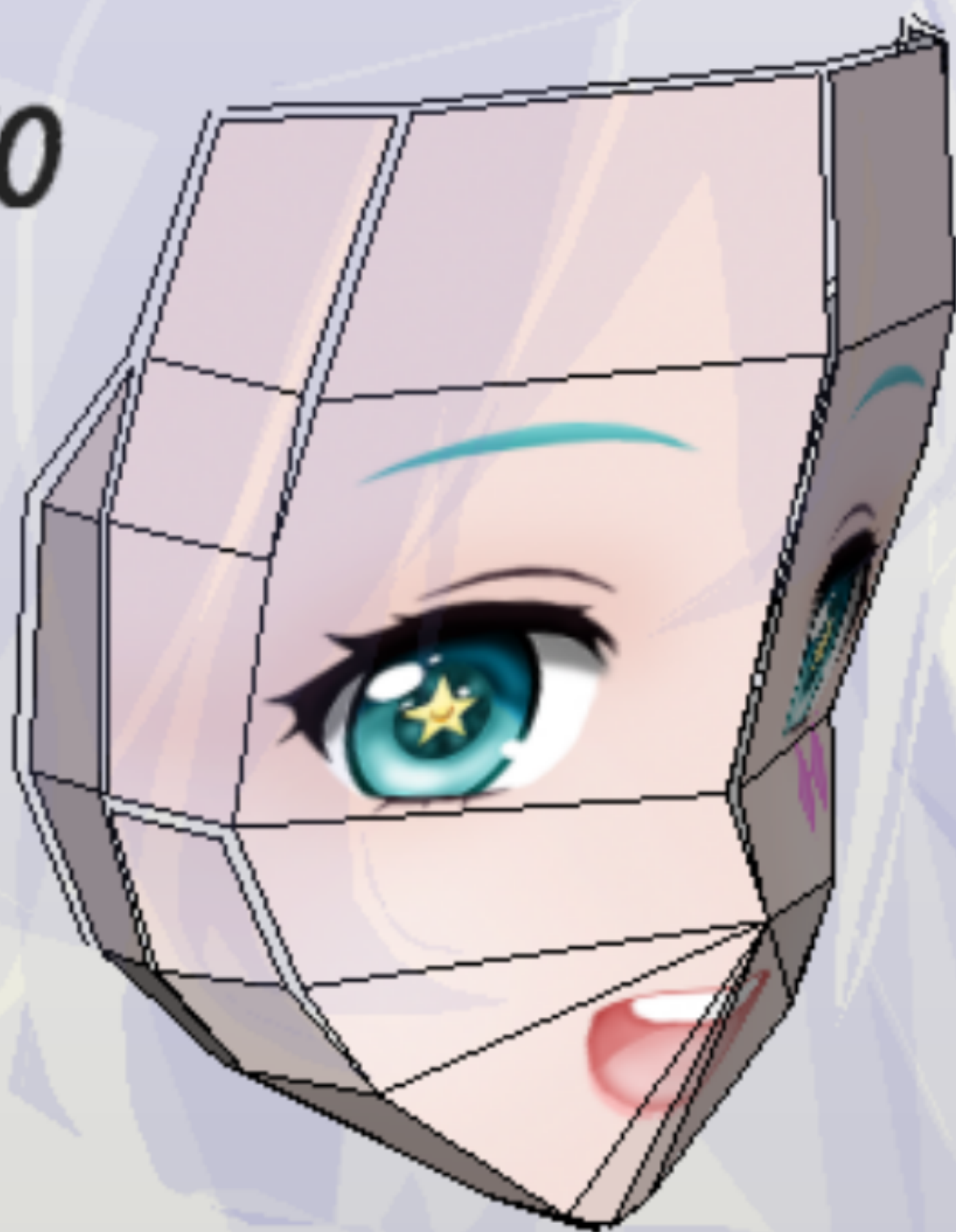

B77

B78

B72

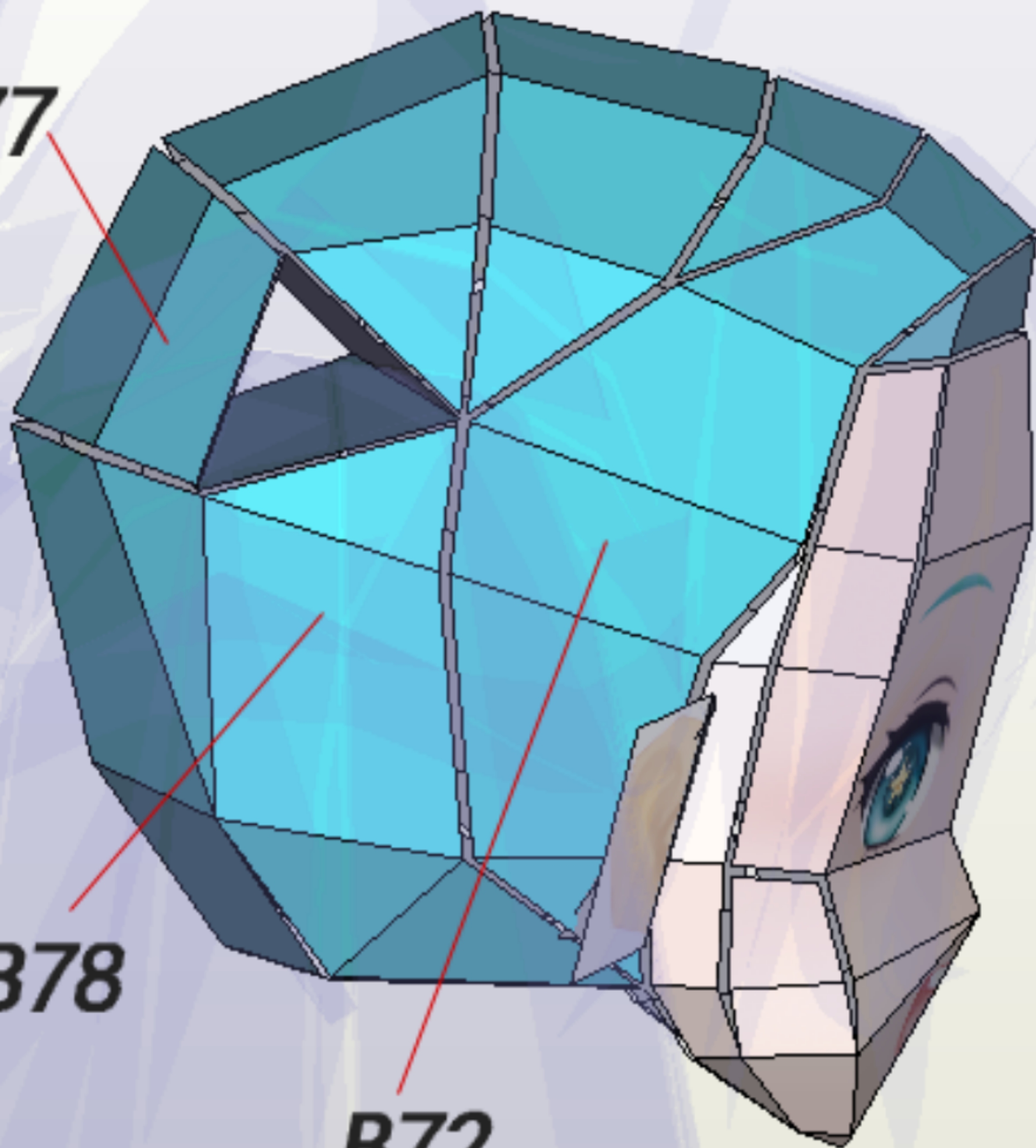

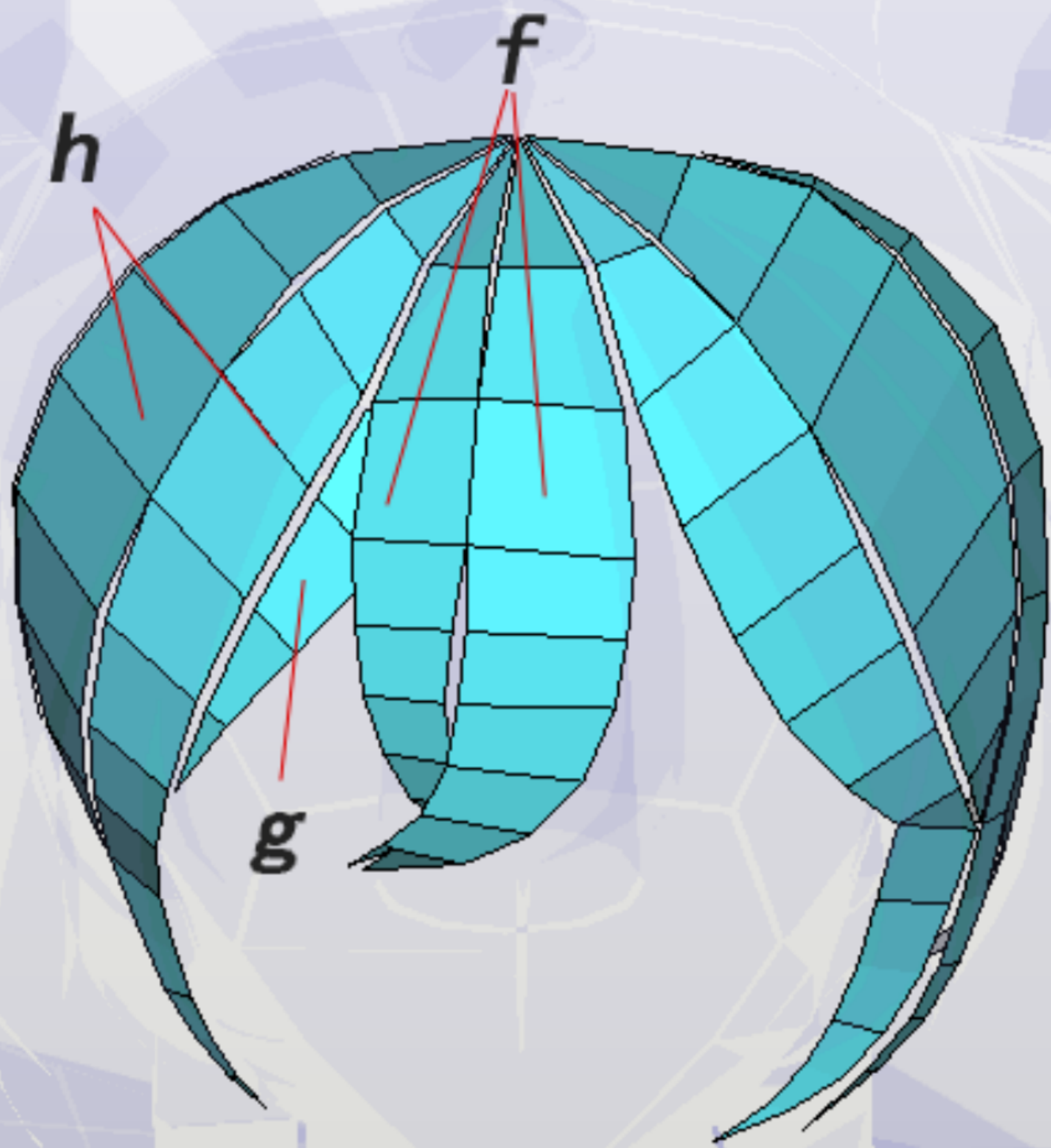

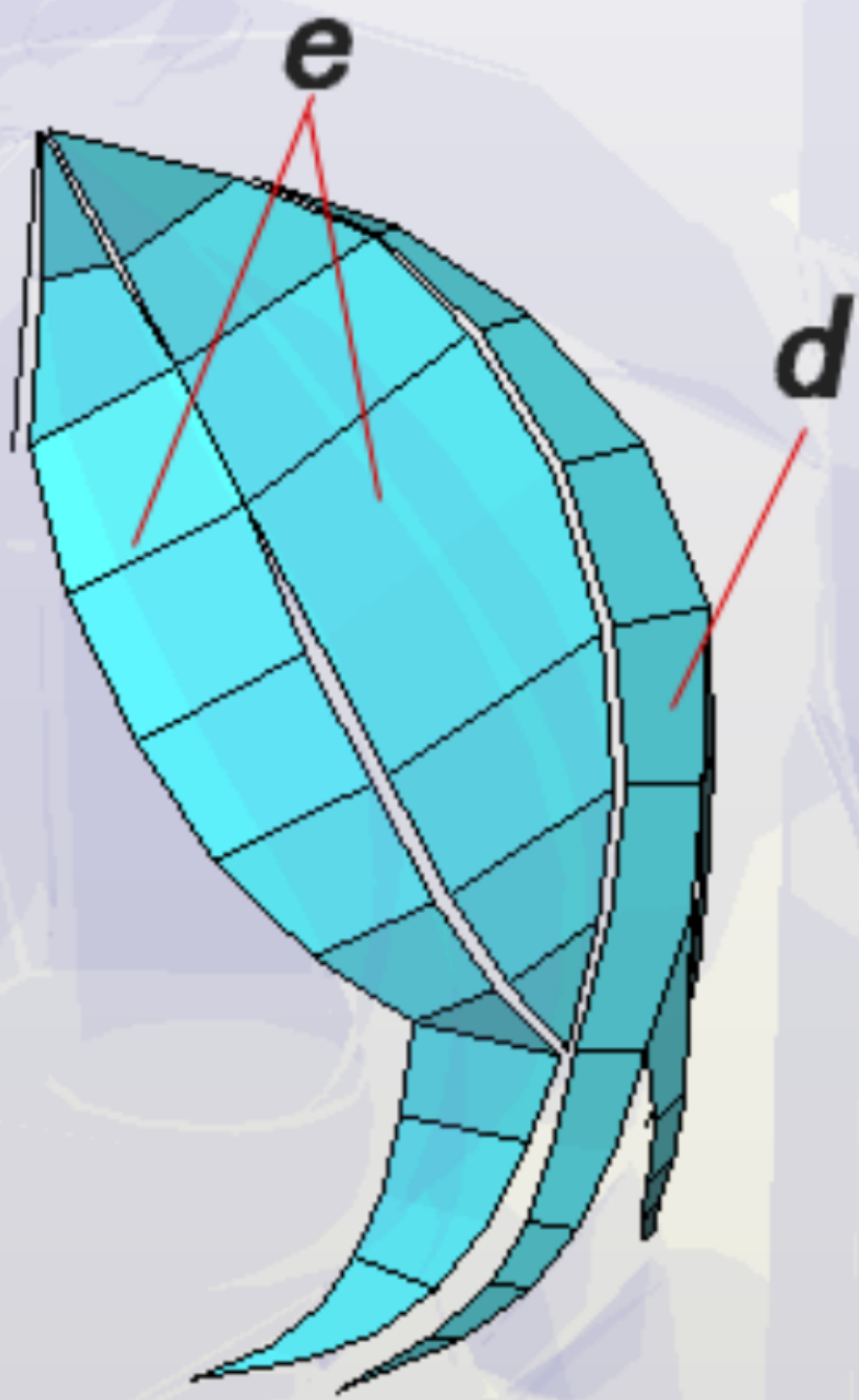

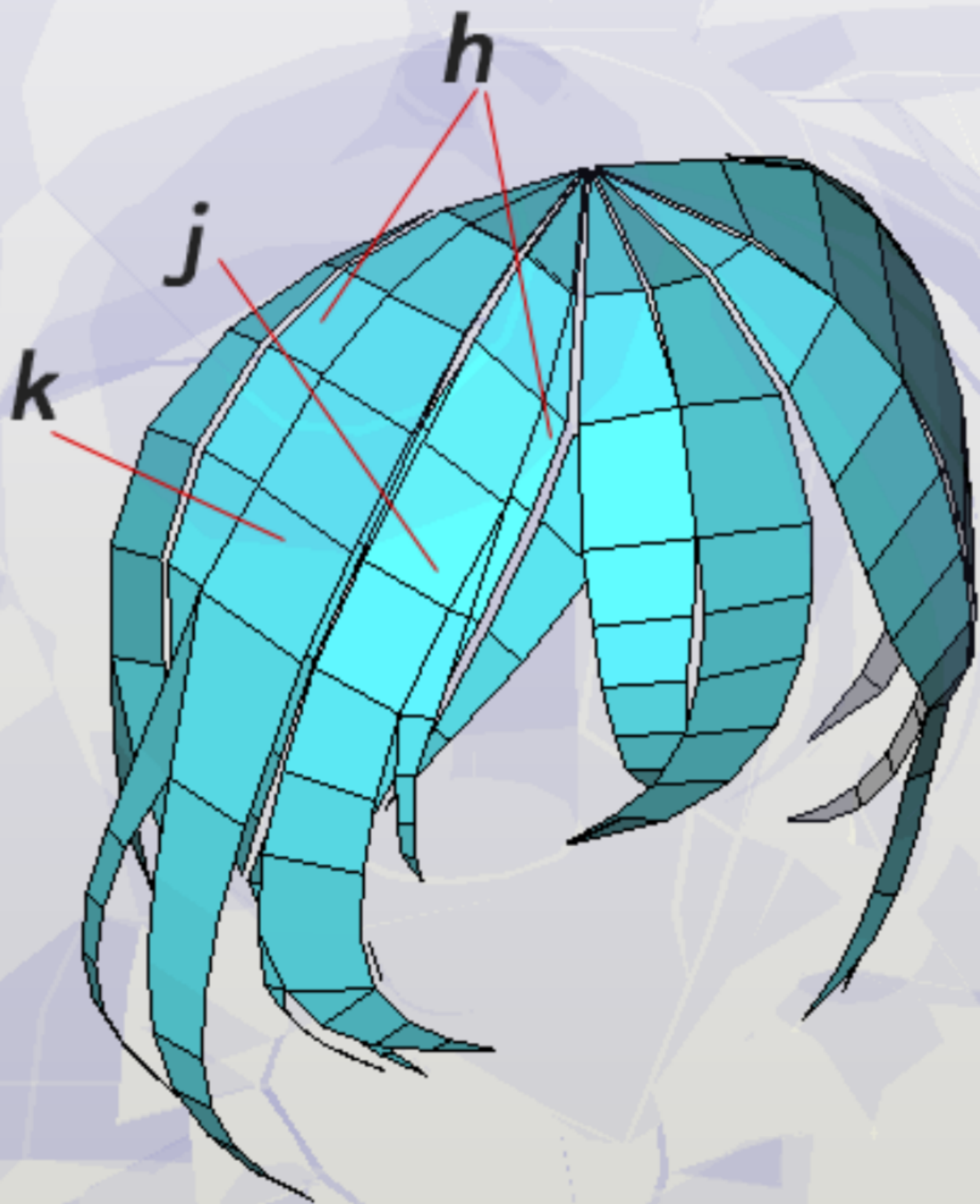

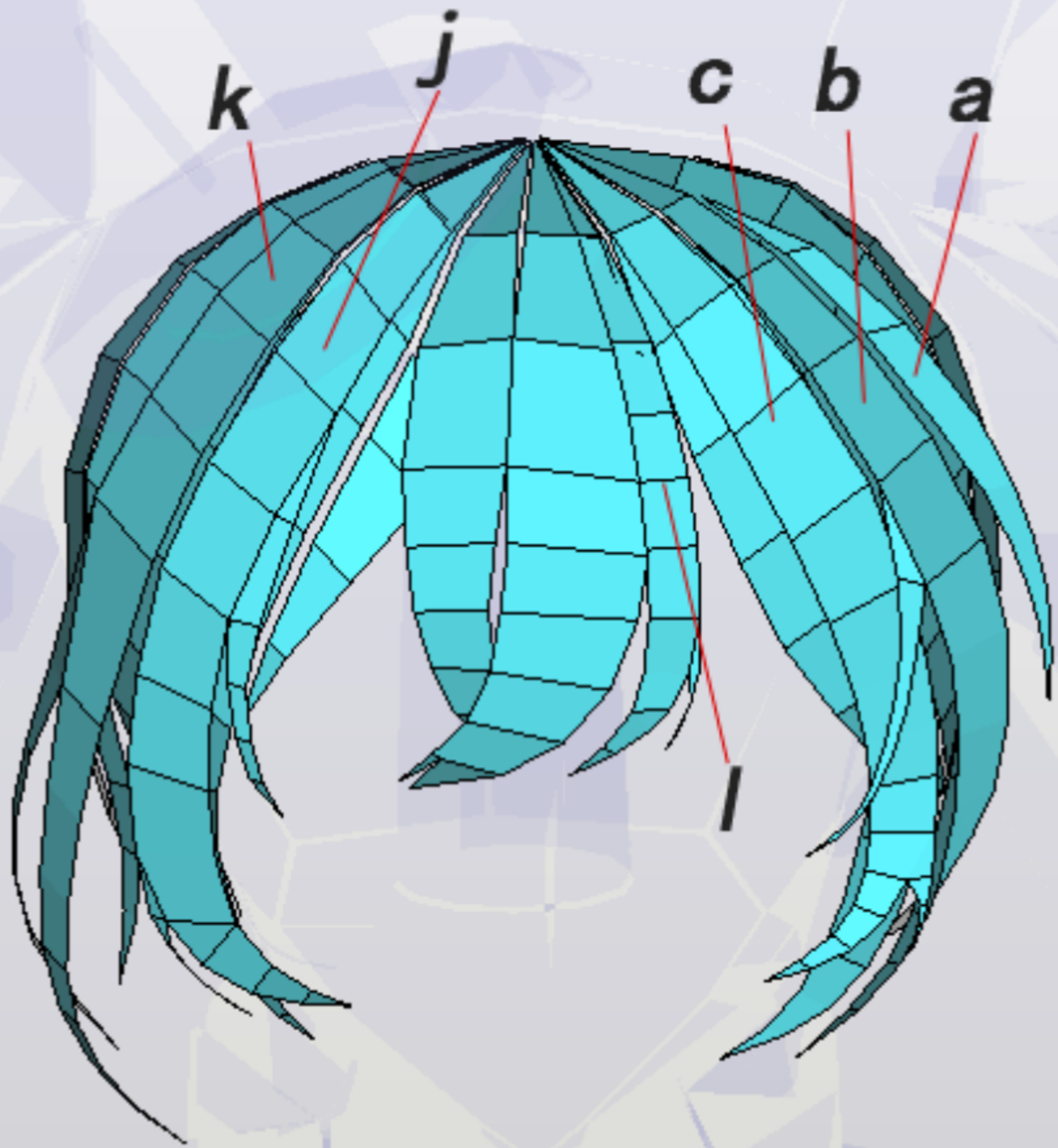



B83

B82





B84

B85

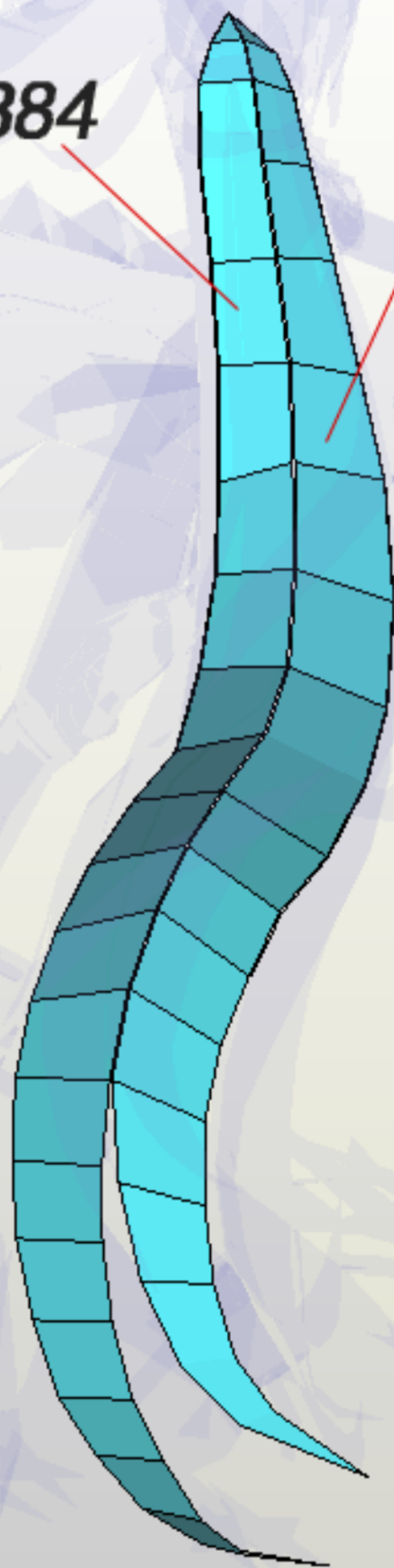

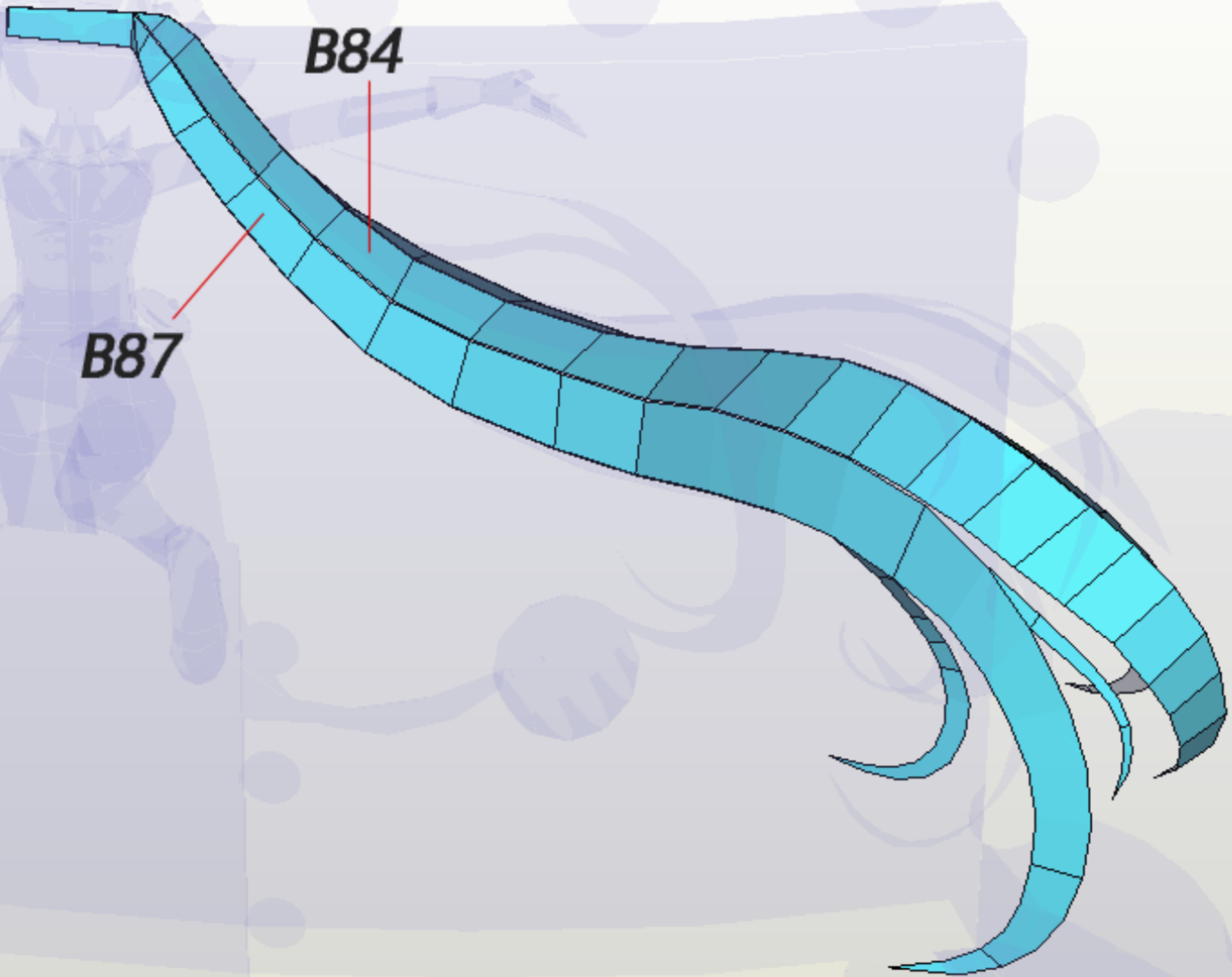

B84

B87

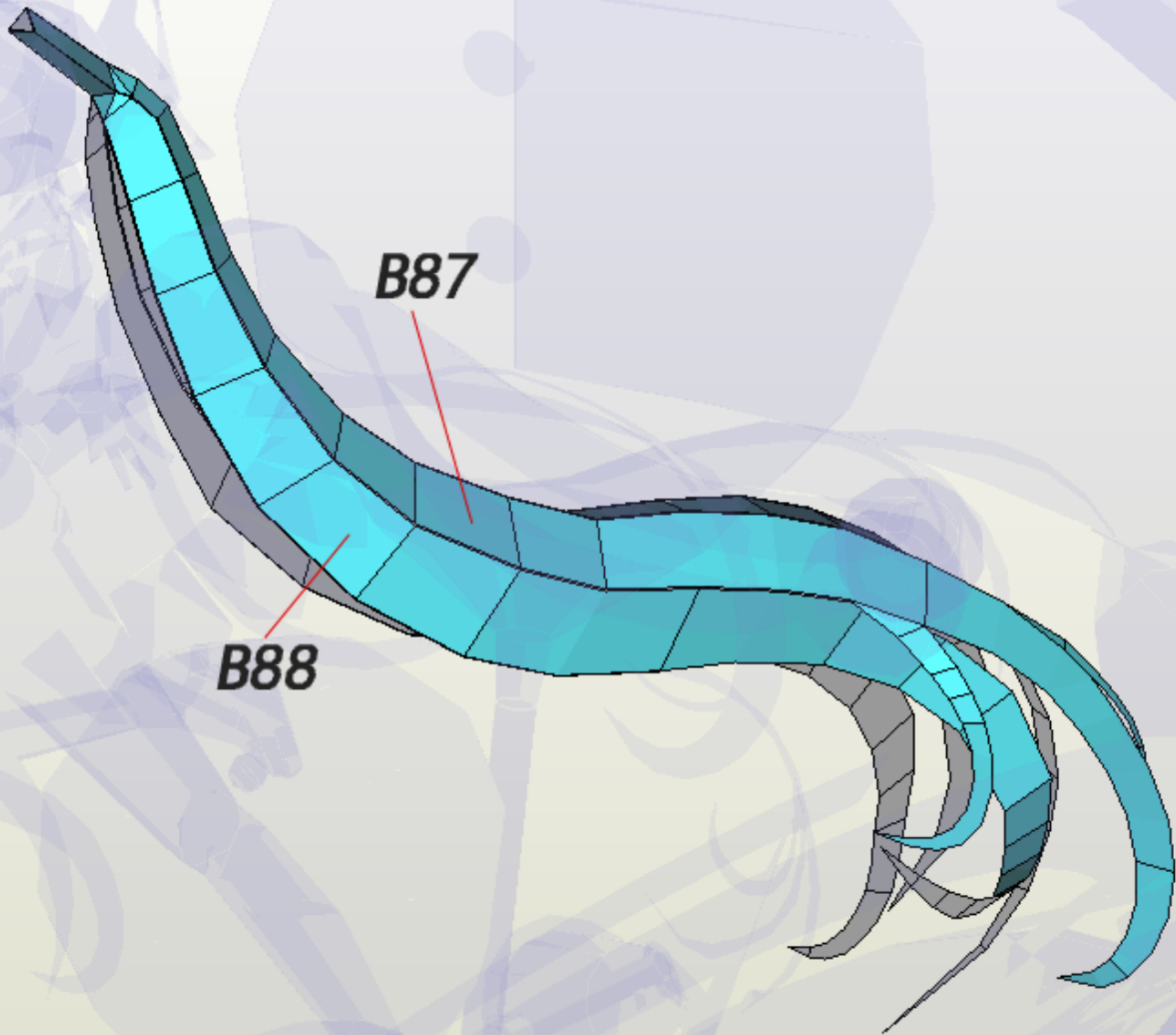

B87

B88

沾B89时最好
B84和B88从上
往下同时沾

B84

B88

B89

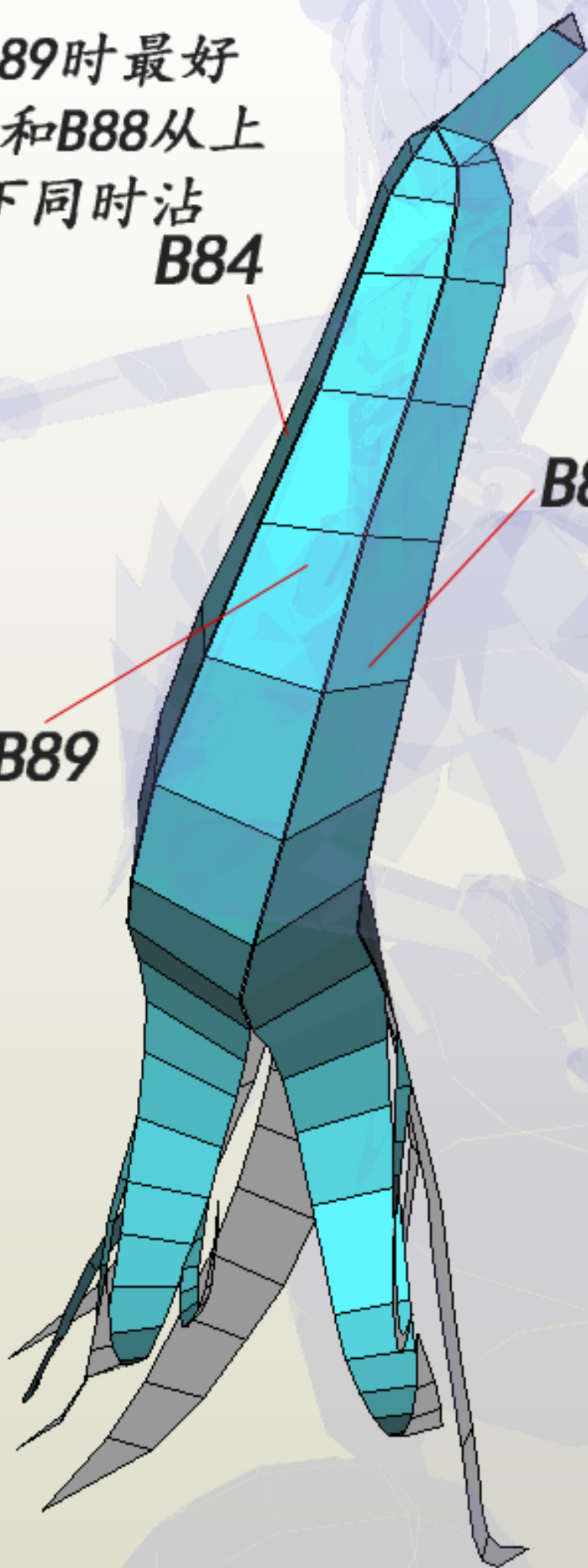

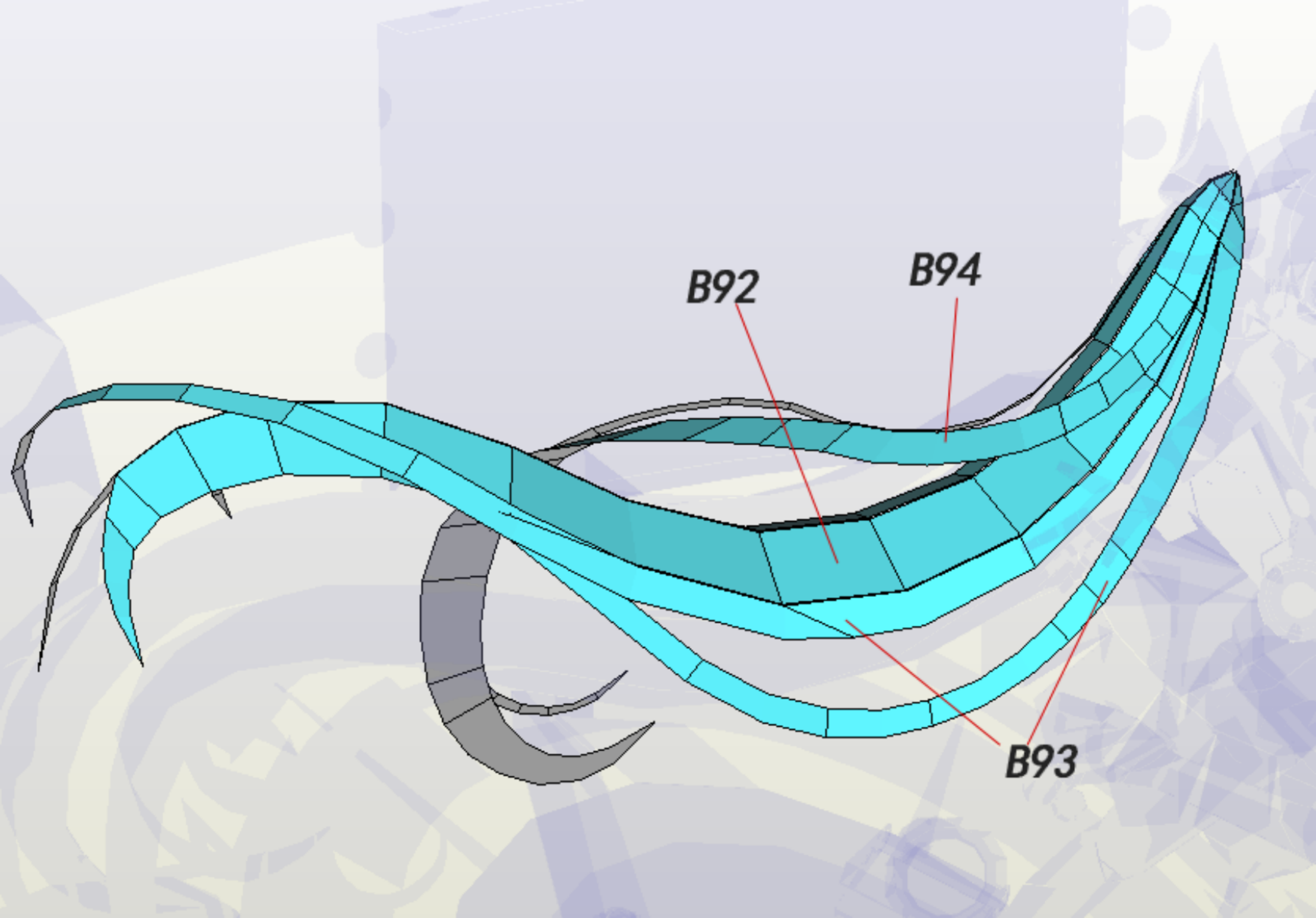

B92

B94

B93

B92沾B85上面
B91沾B84上面

B85

B92

B86

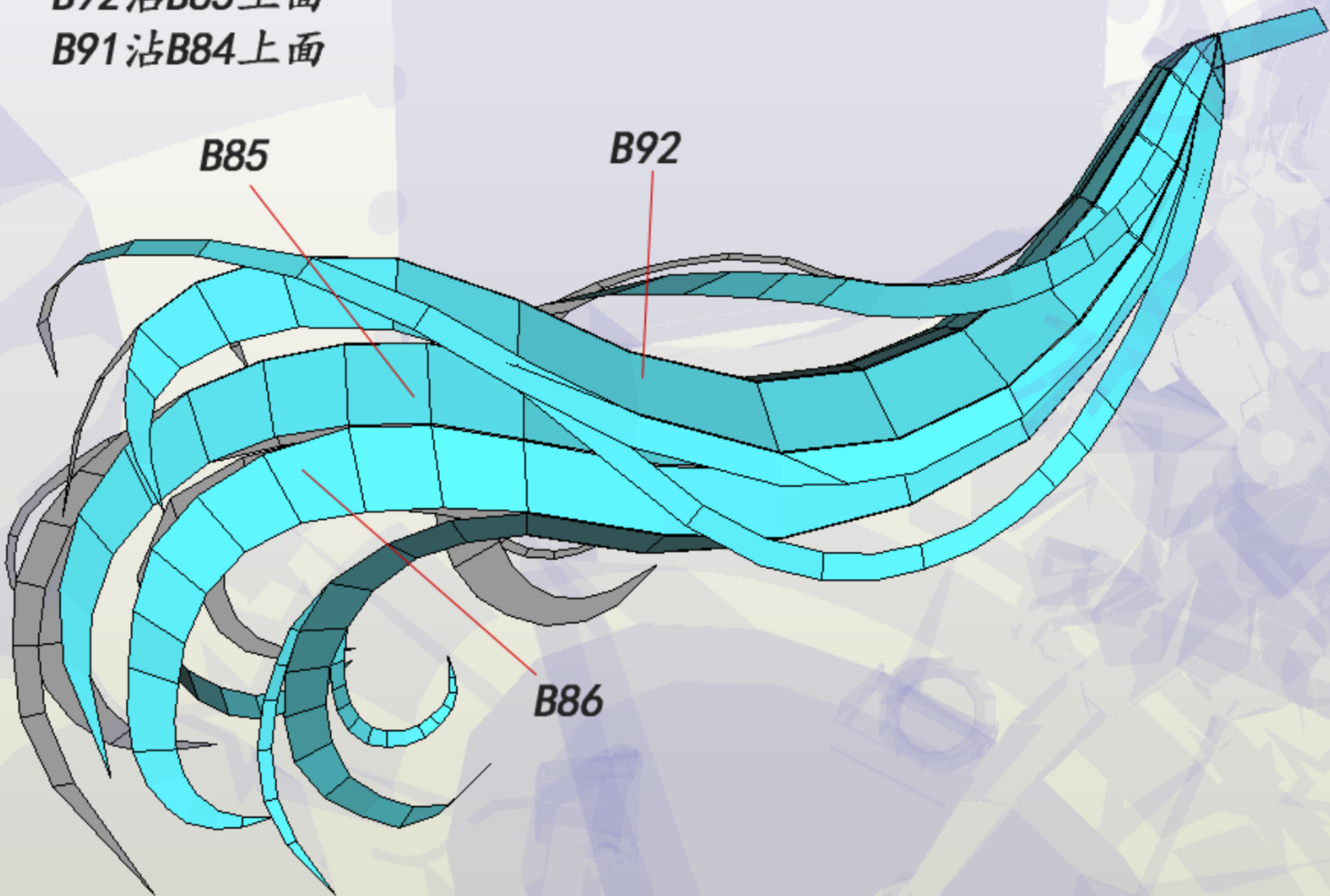

顶视图

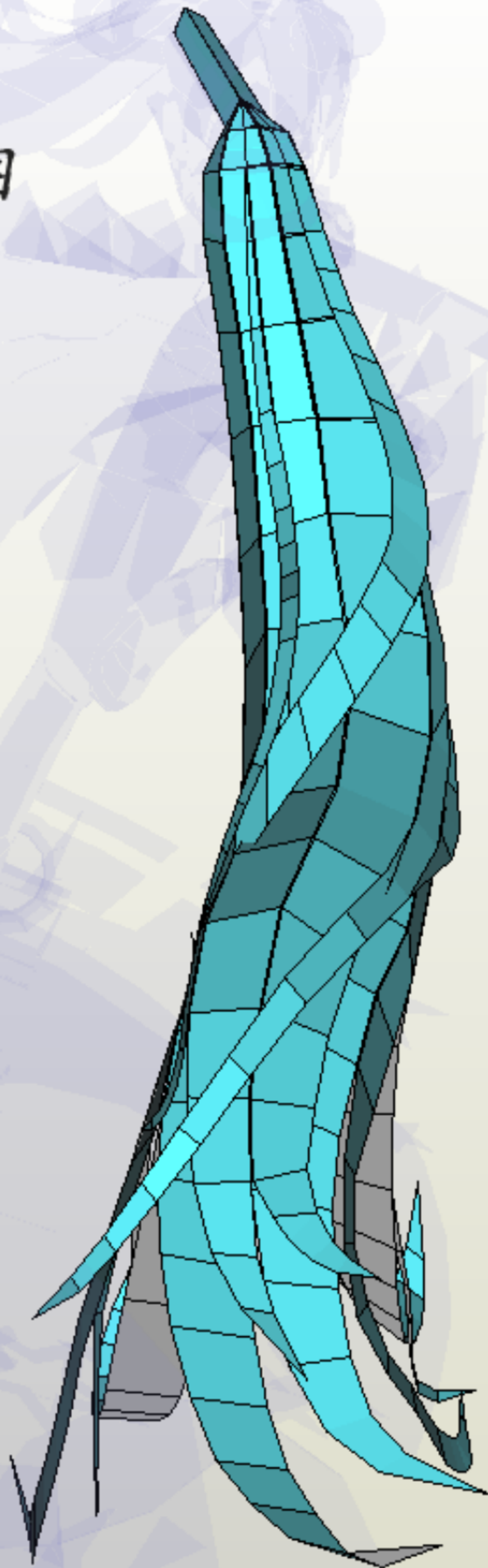

后视图

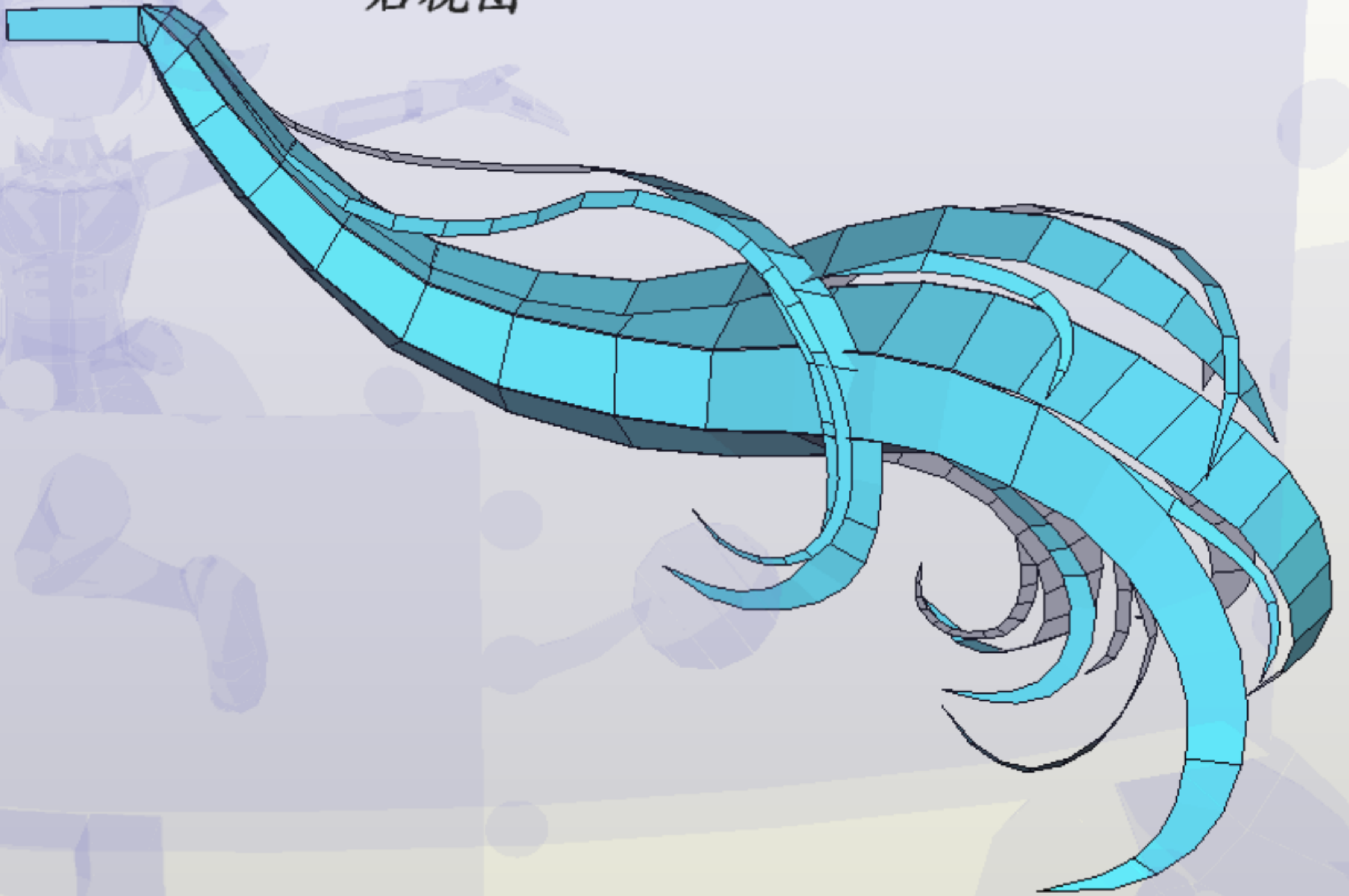

B94

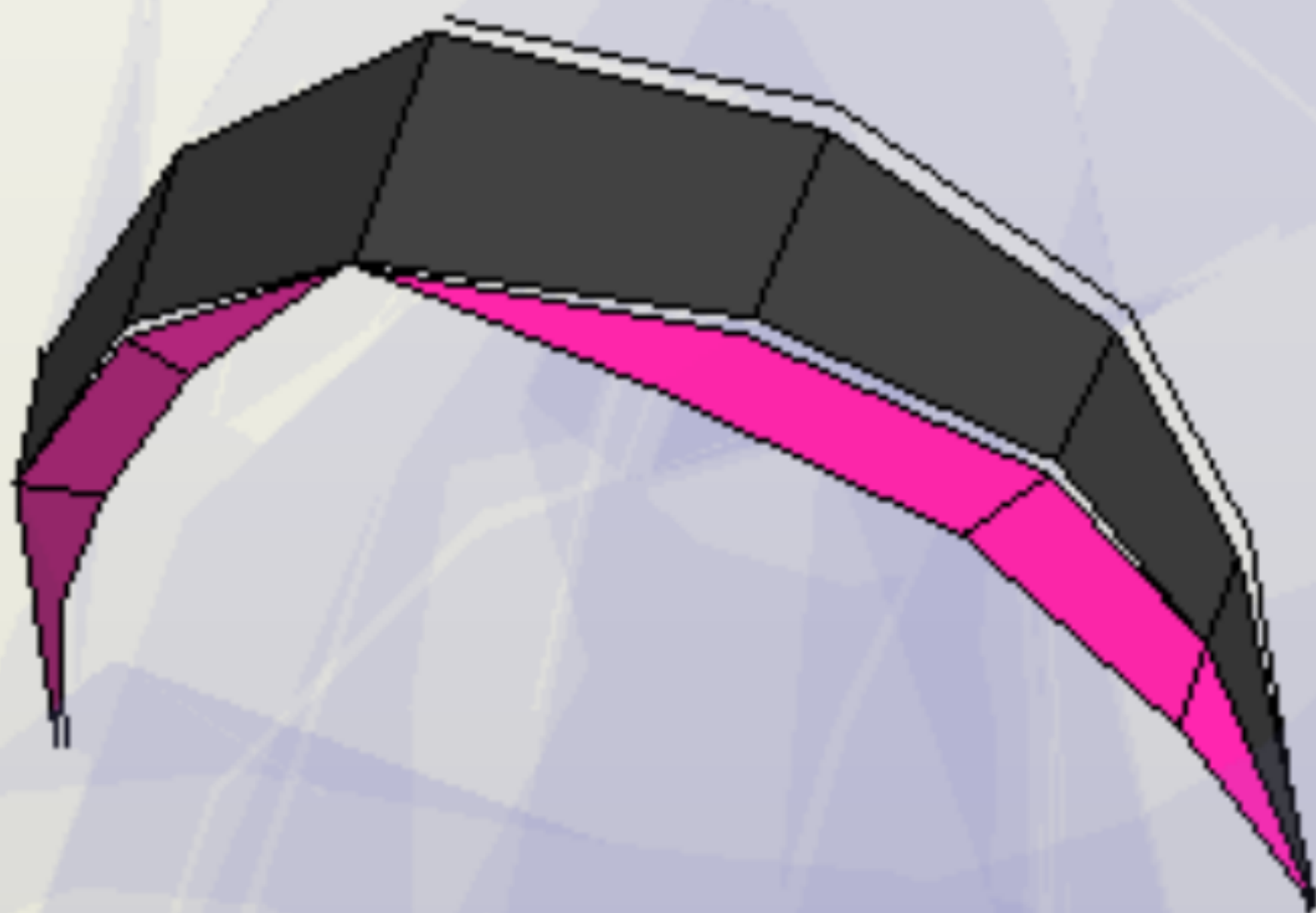

B96a

B96

B96b

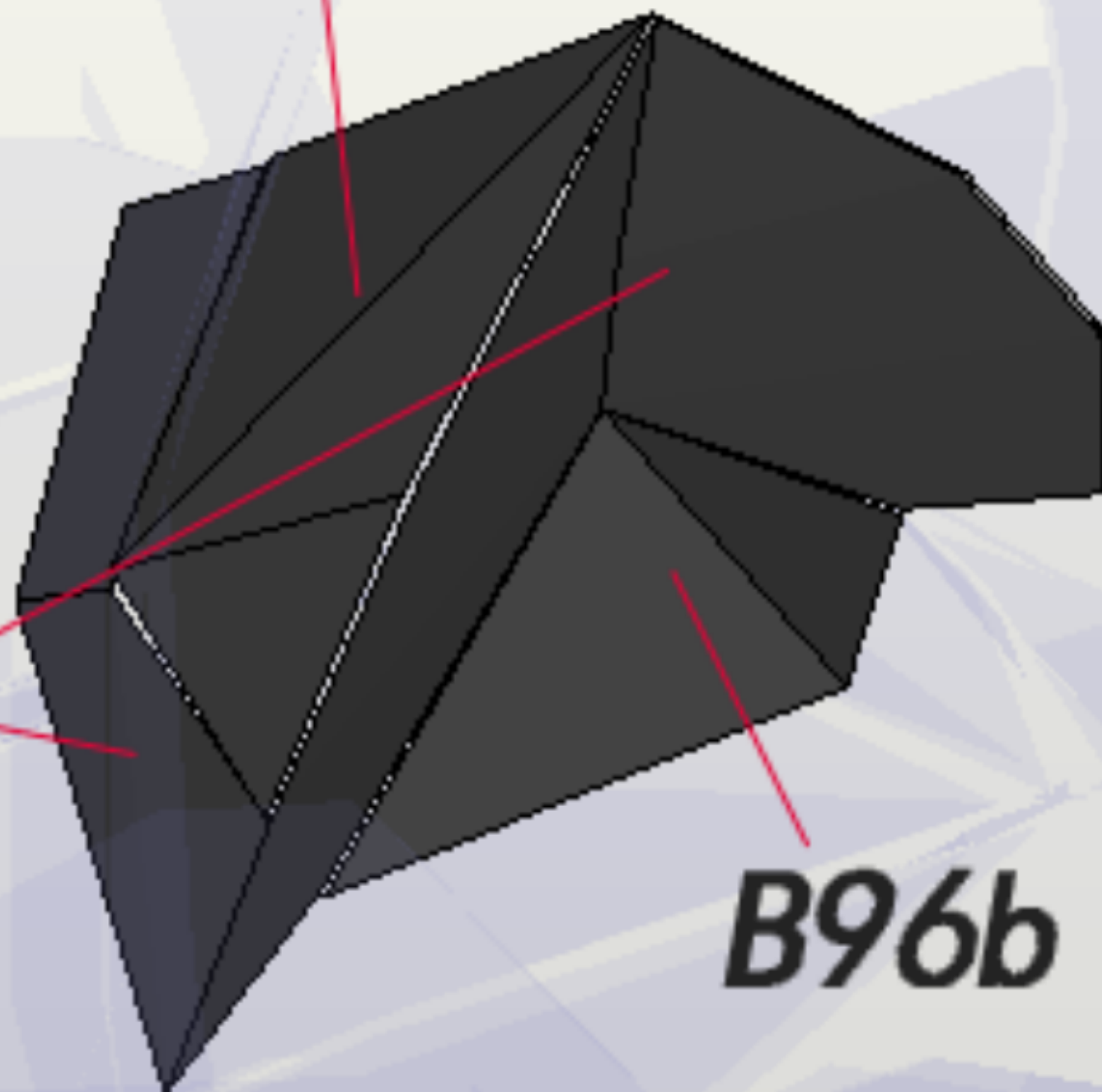

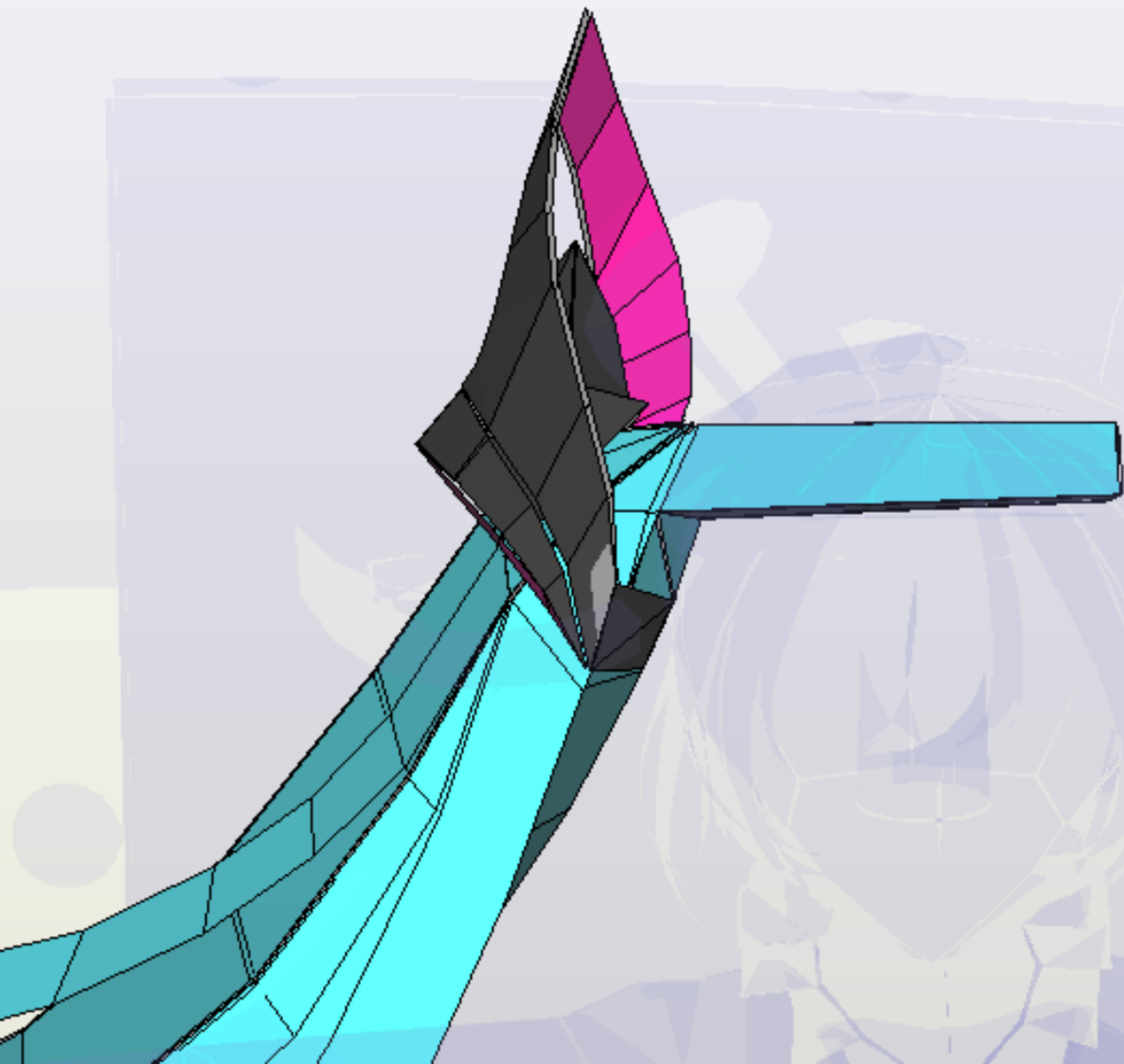

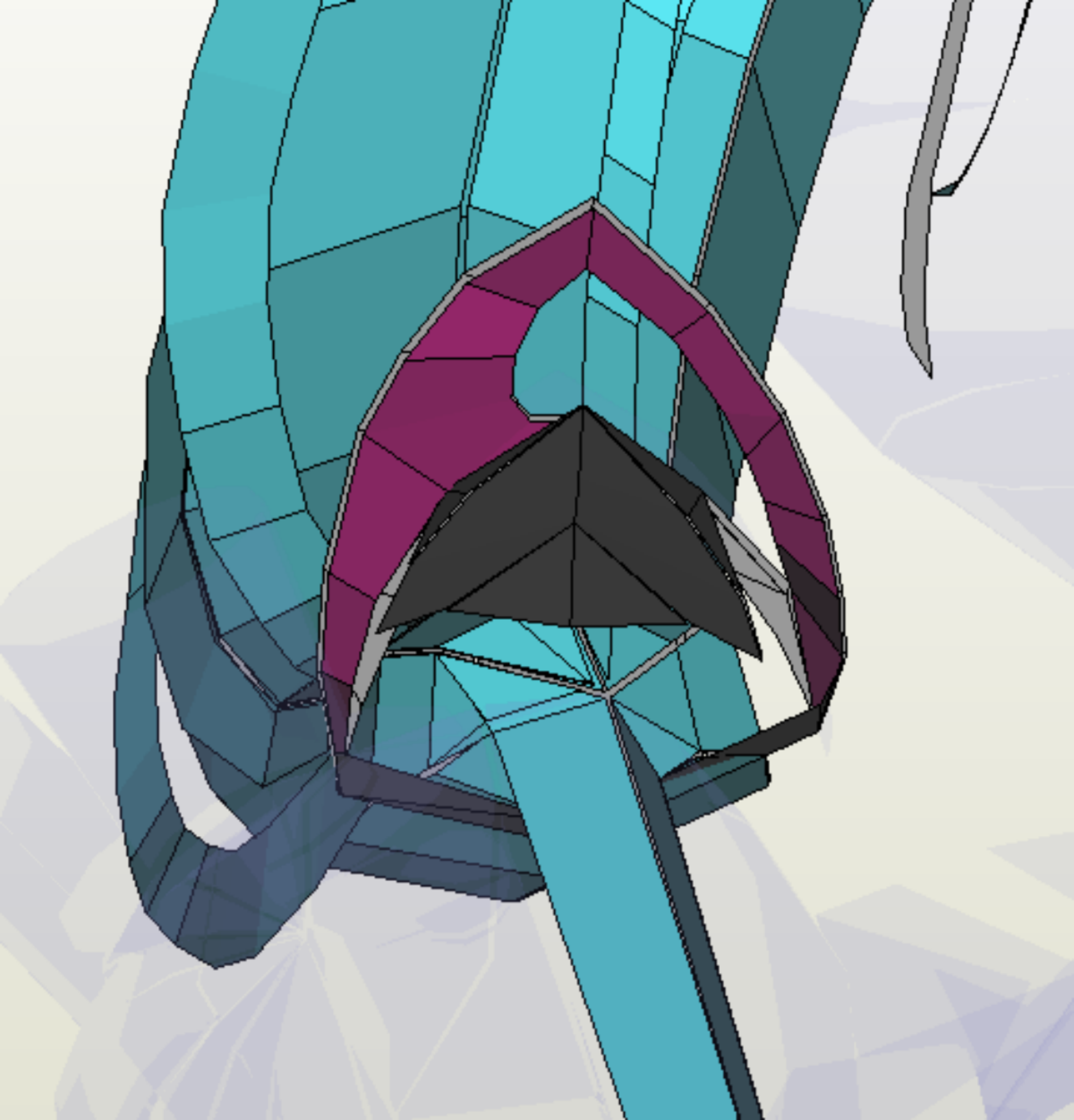

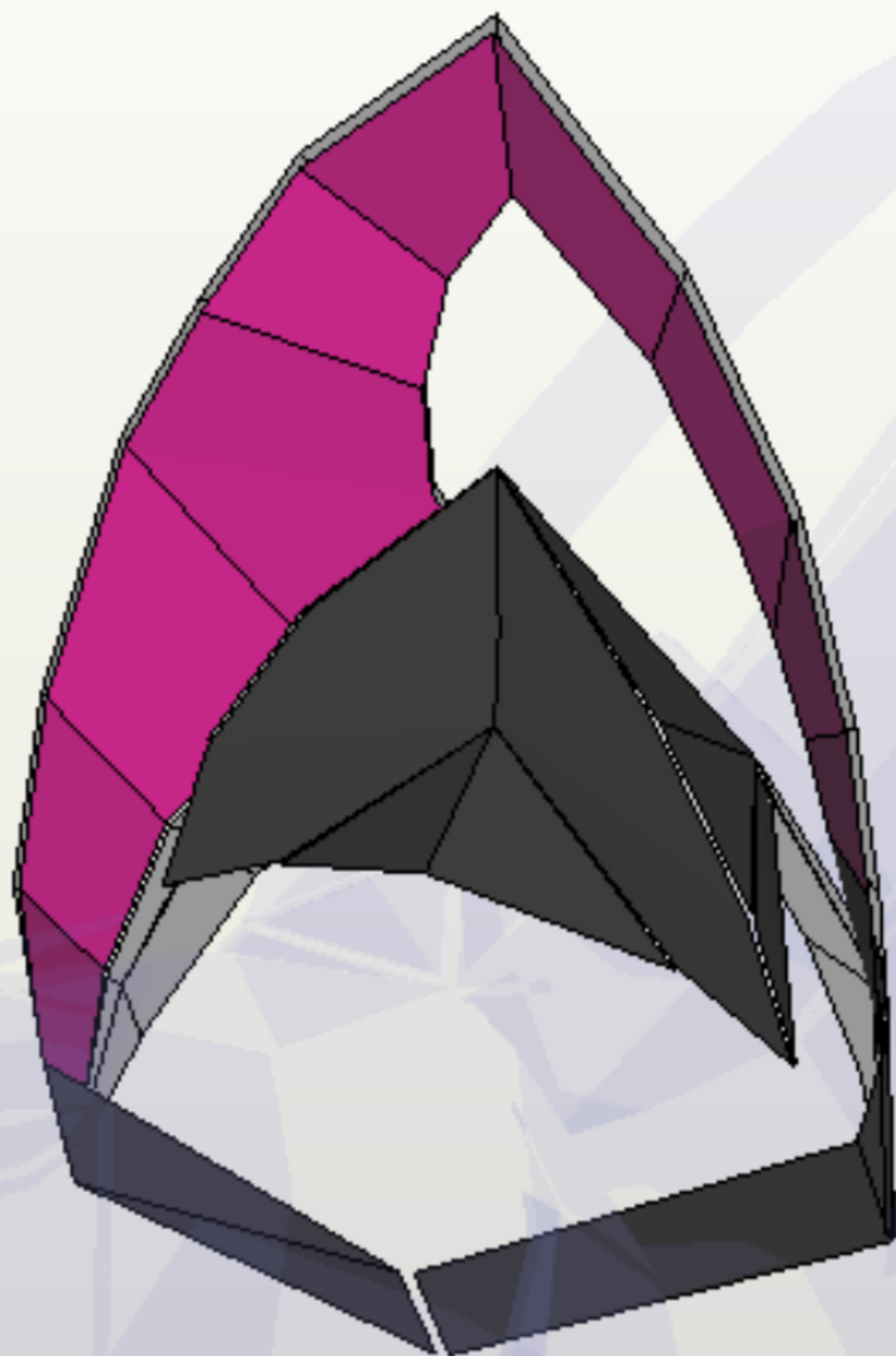

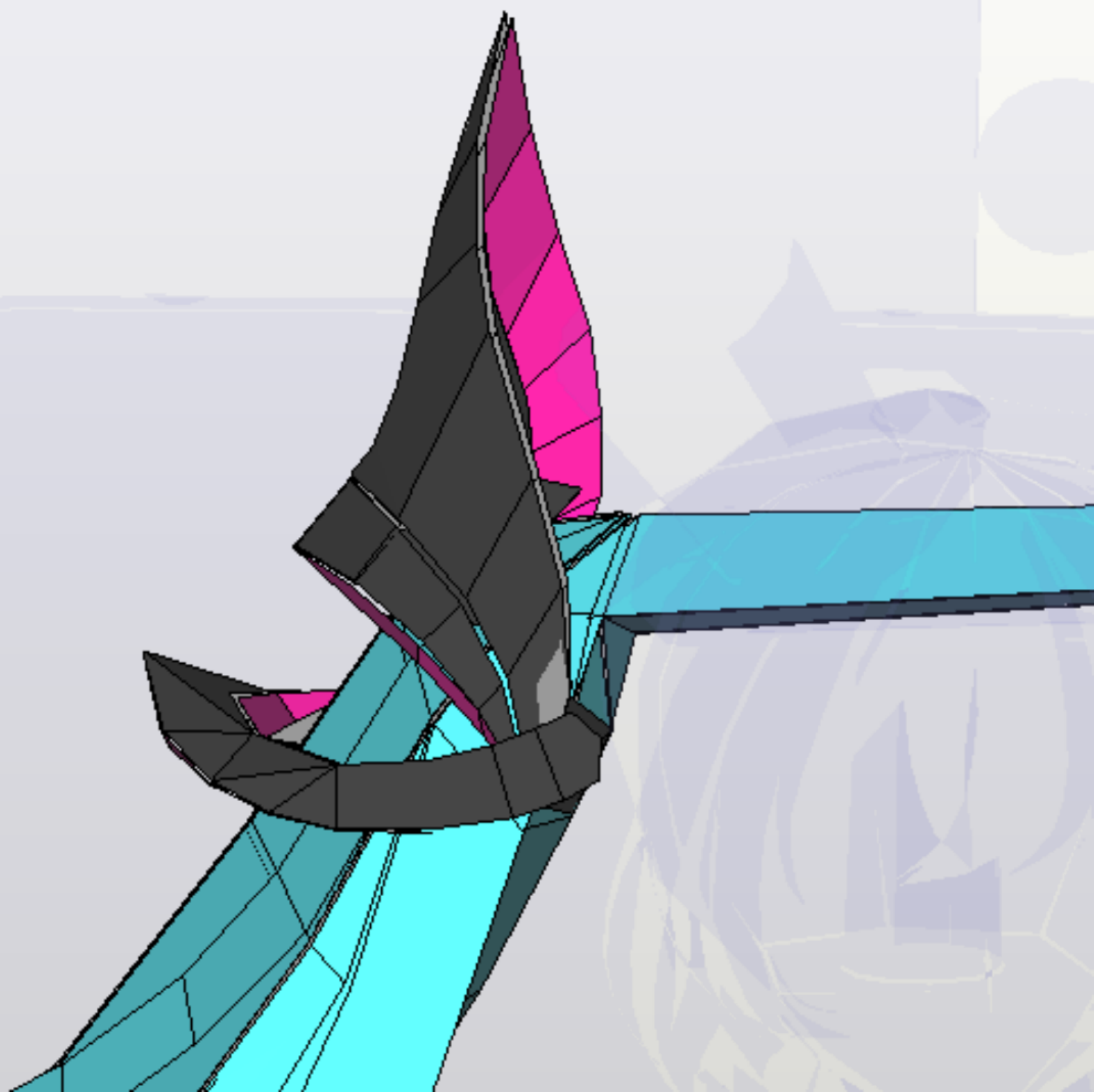

B97



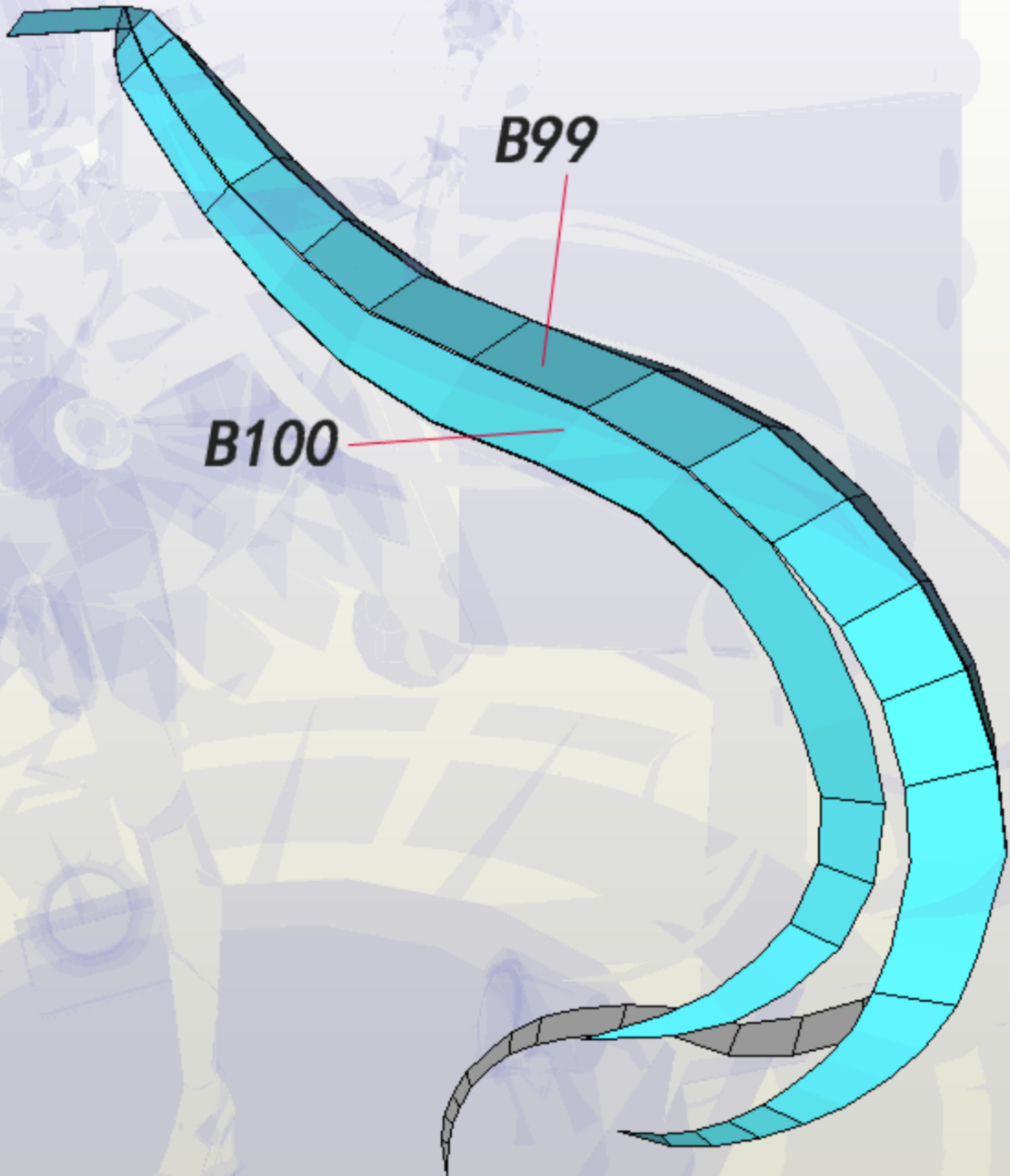

B99

B100

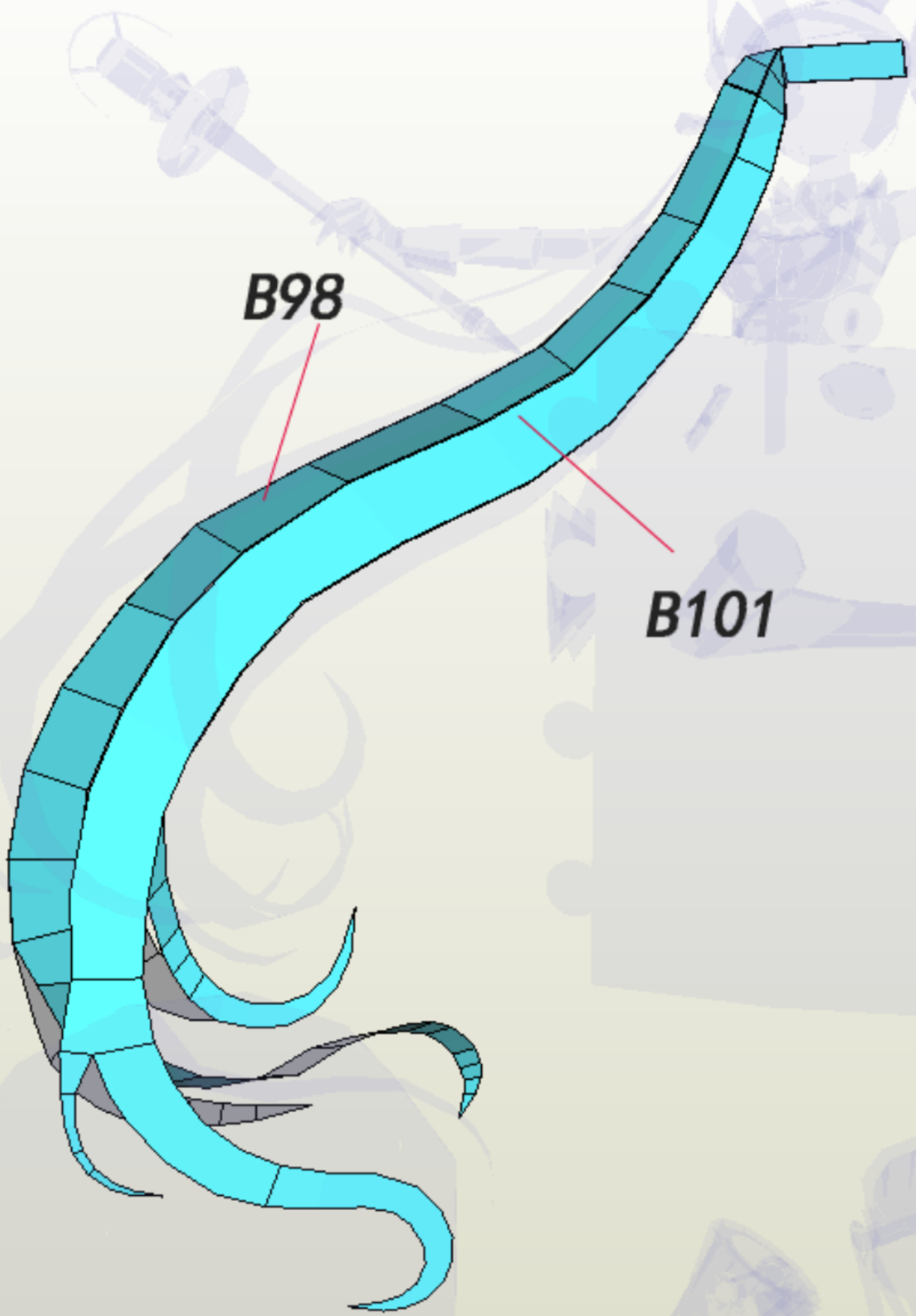

B98

B101

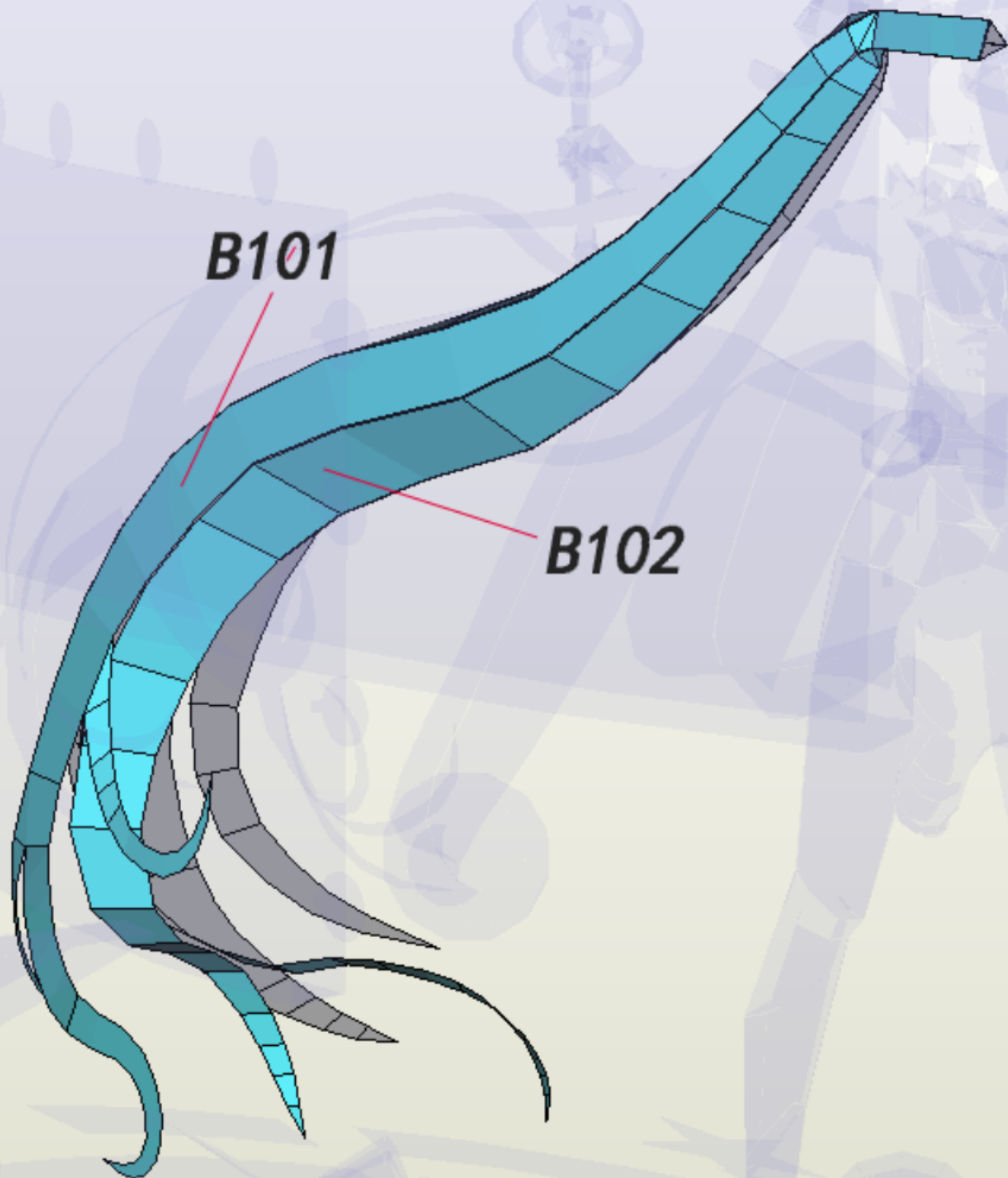

B101

B102

B102

B103

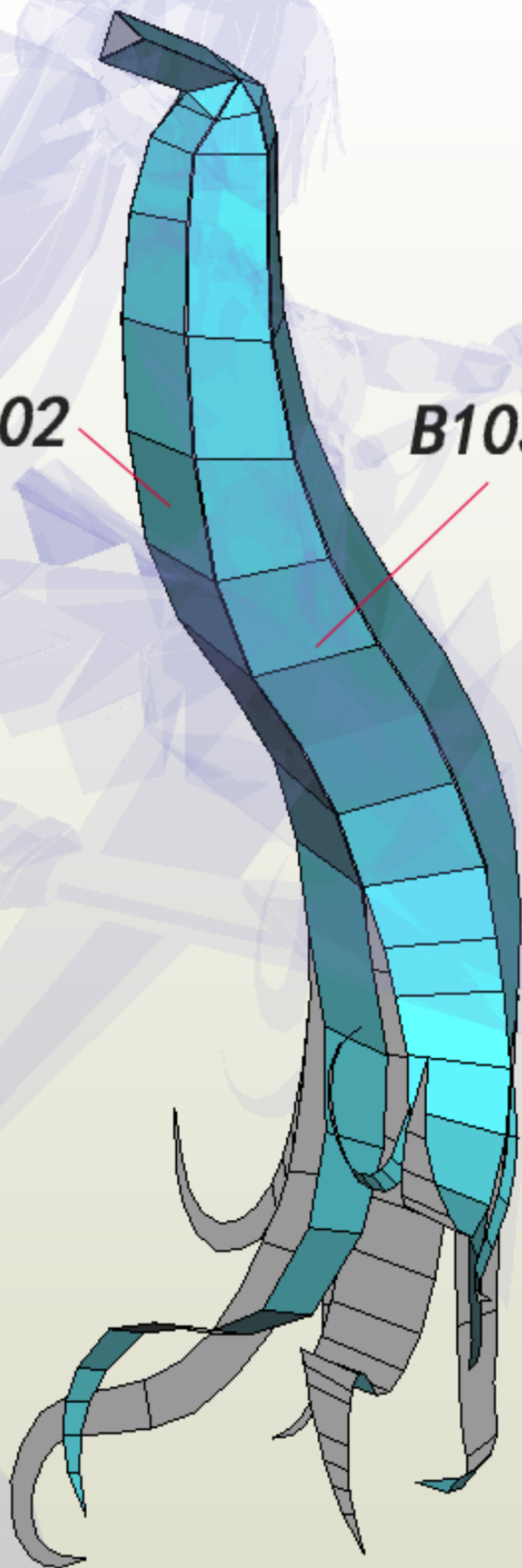

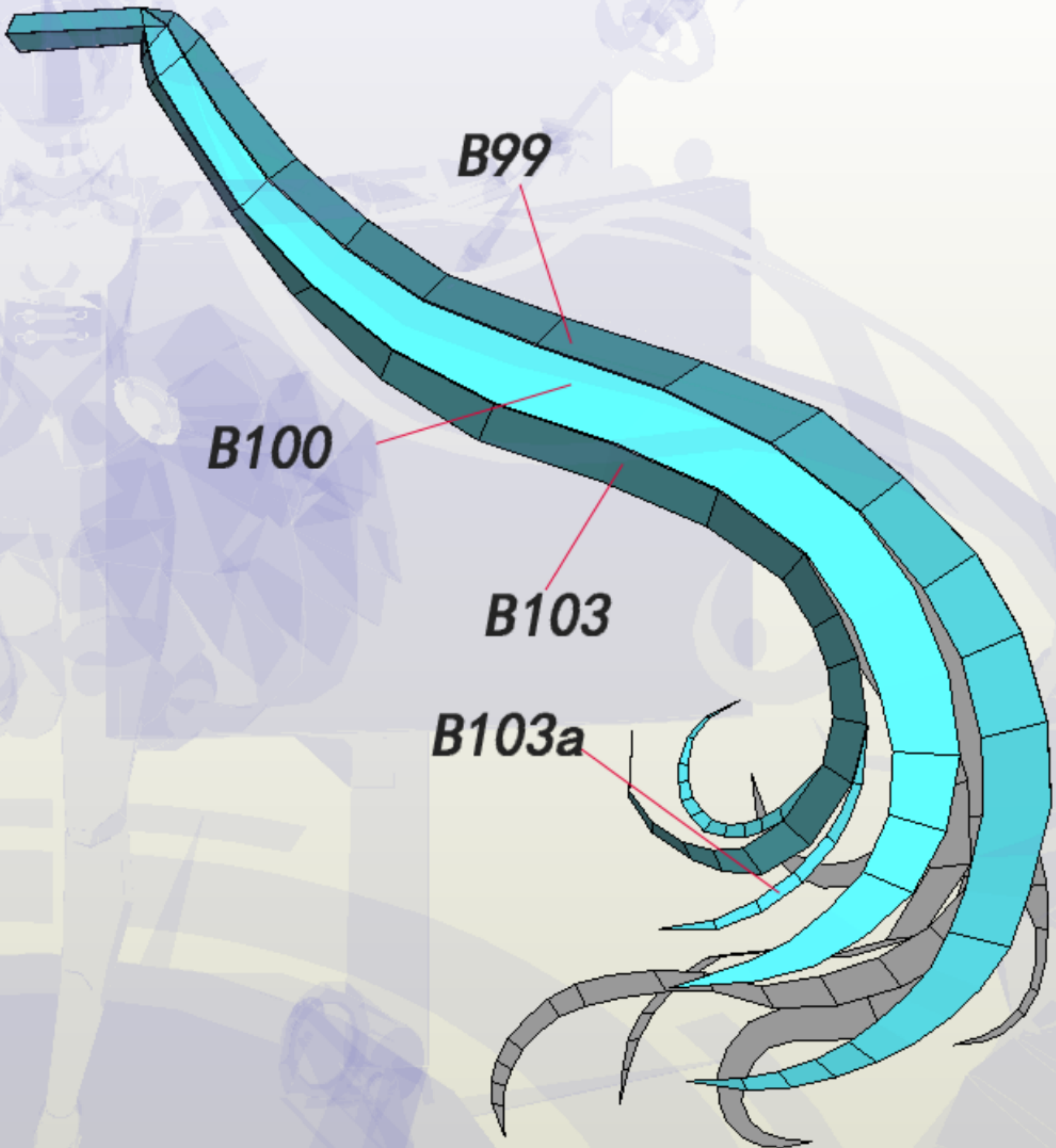

B99

B100

B103

B103a

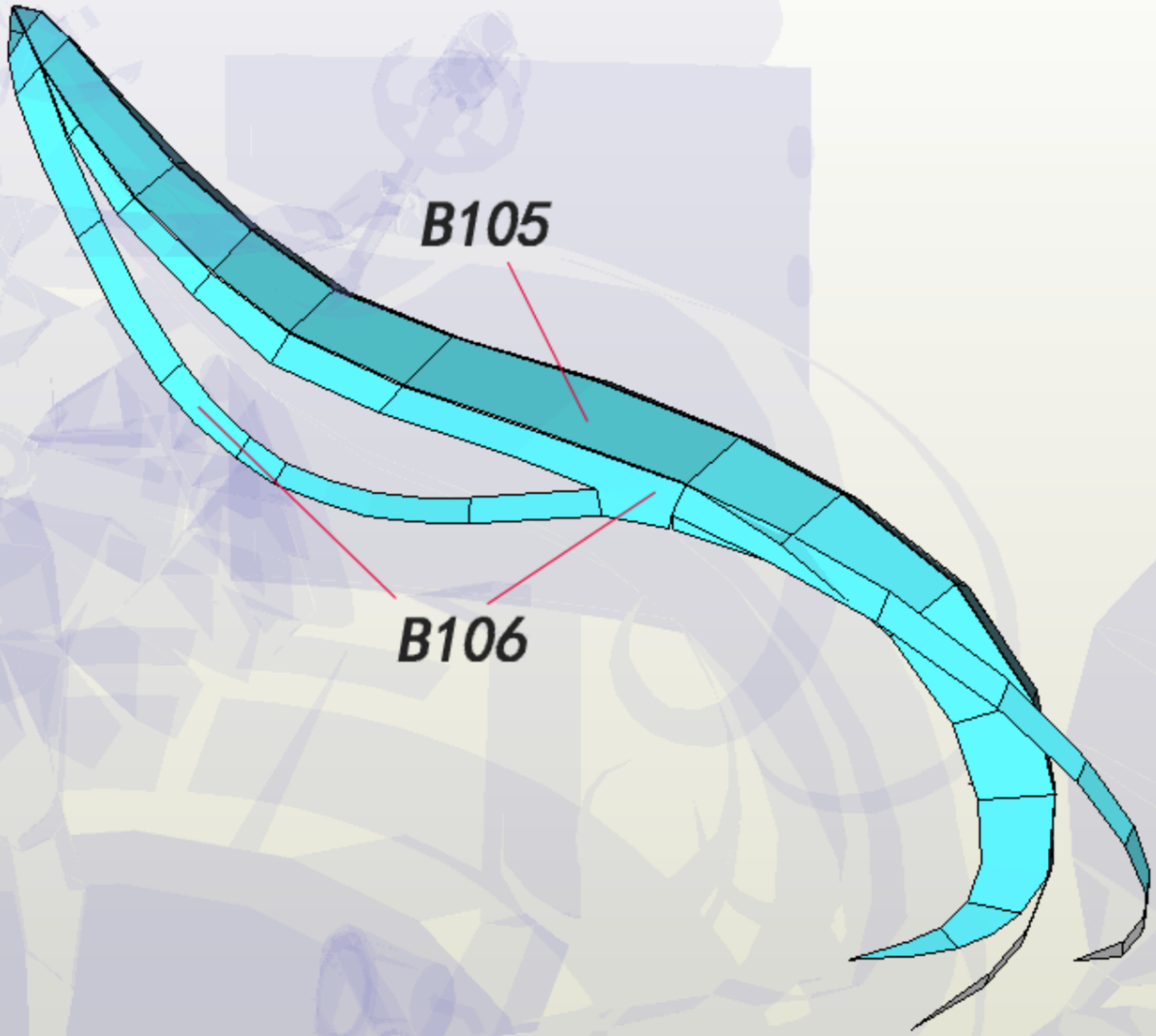

B105

B106

B105沾B99上面
B104沾B98上面

B105

B99

B106

B100

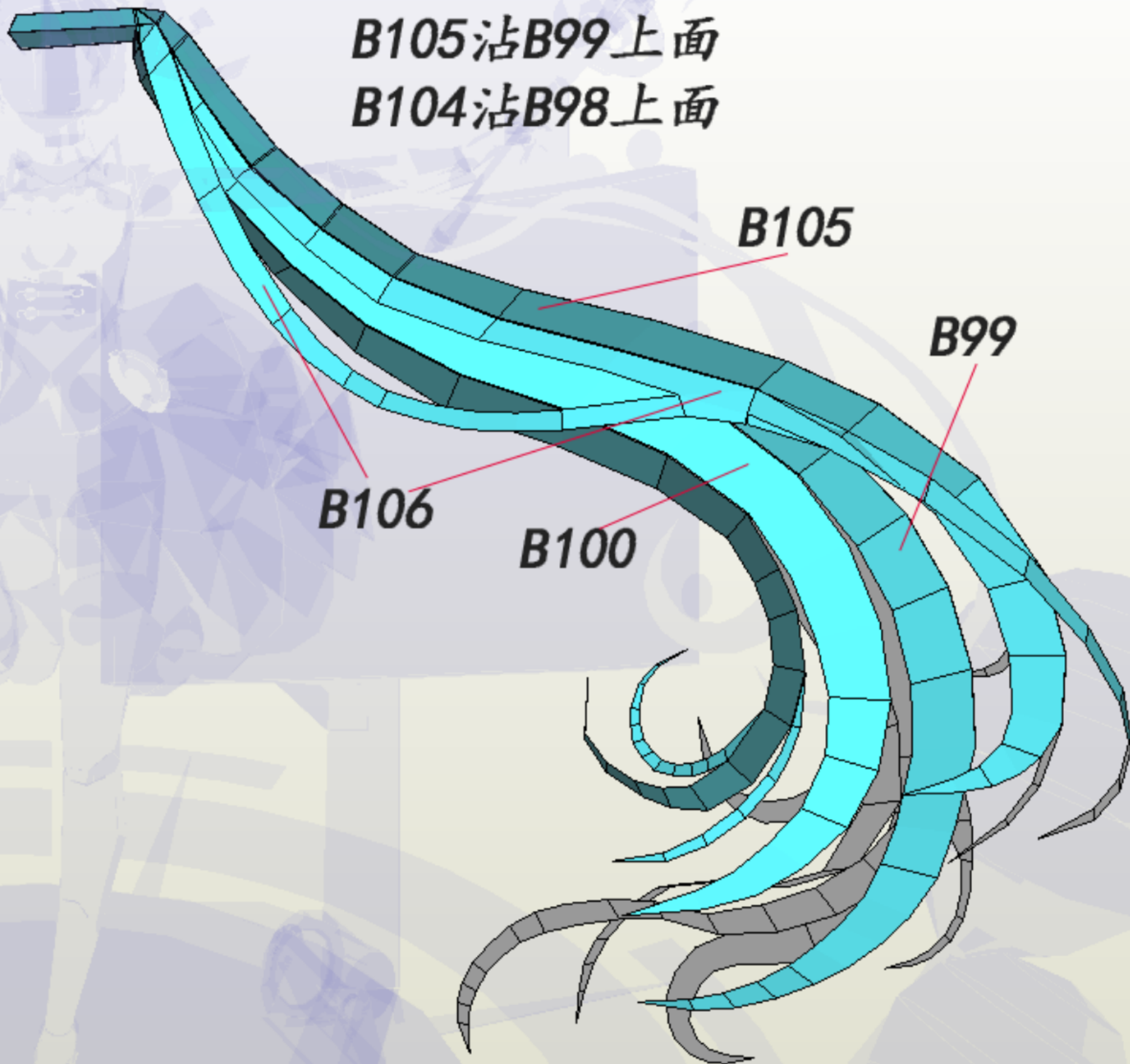



黑球底部
划一刀裙摆
插进去即可

B63a

B64a

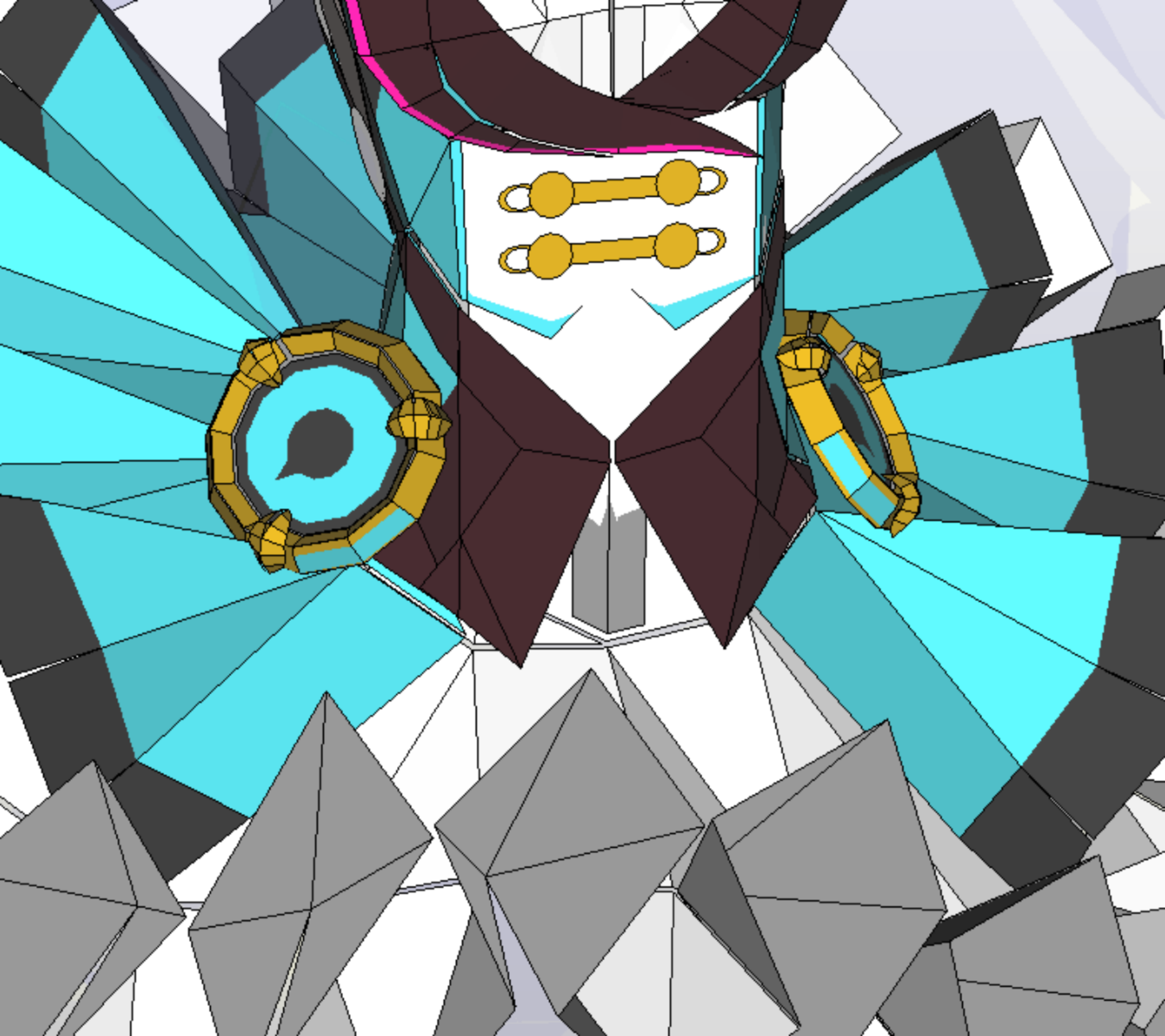

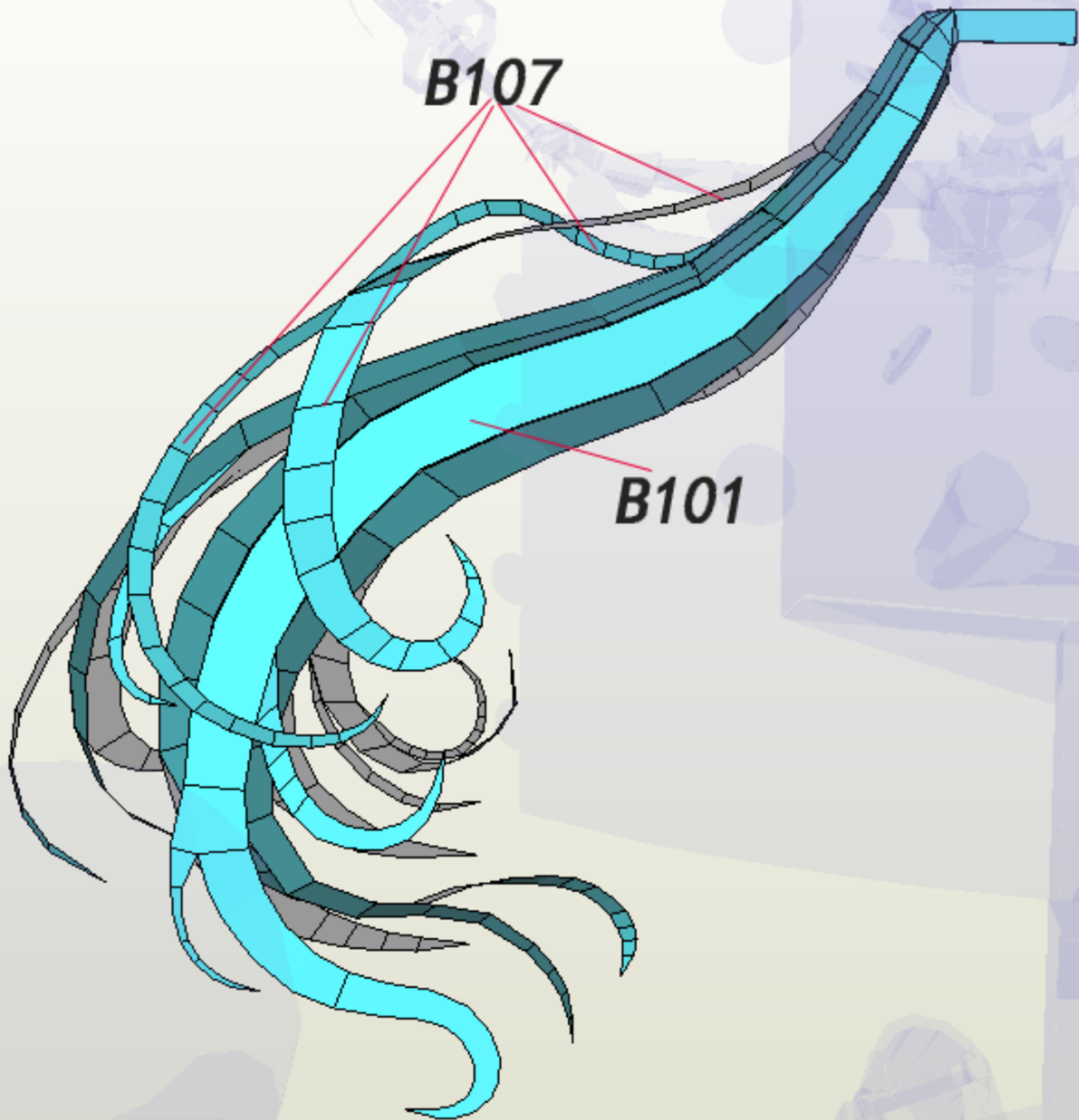

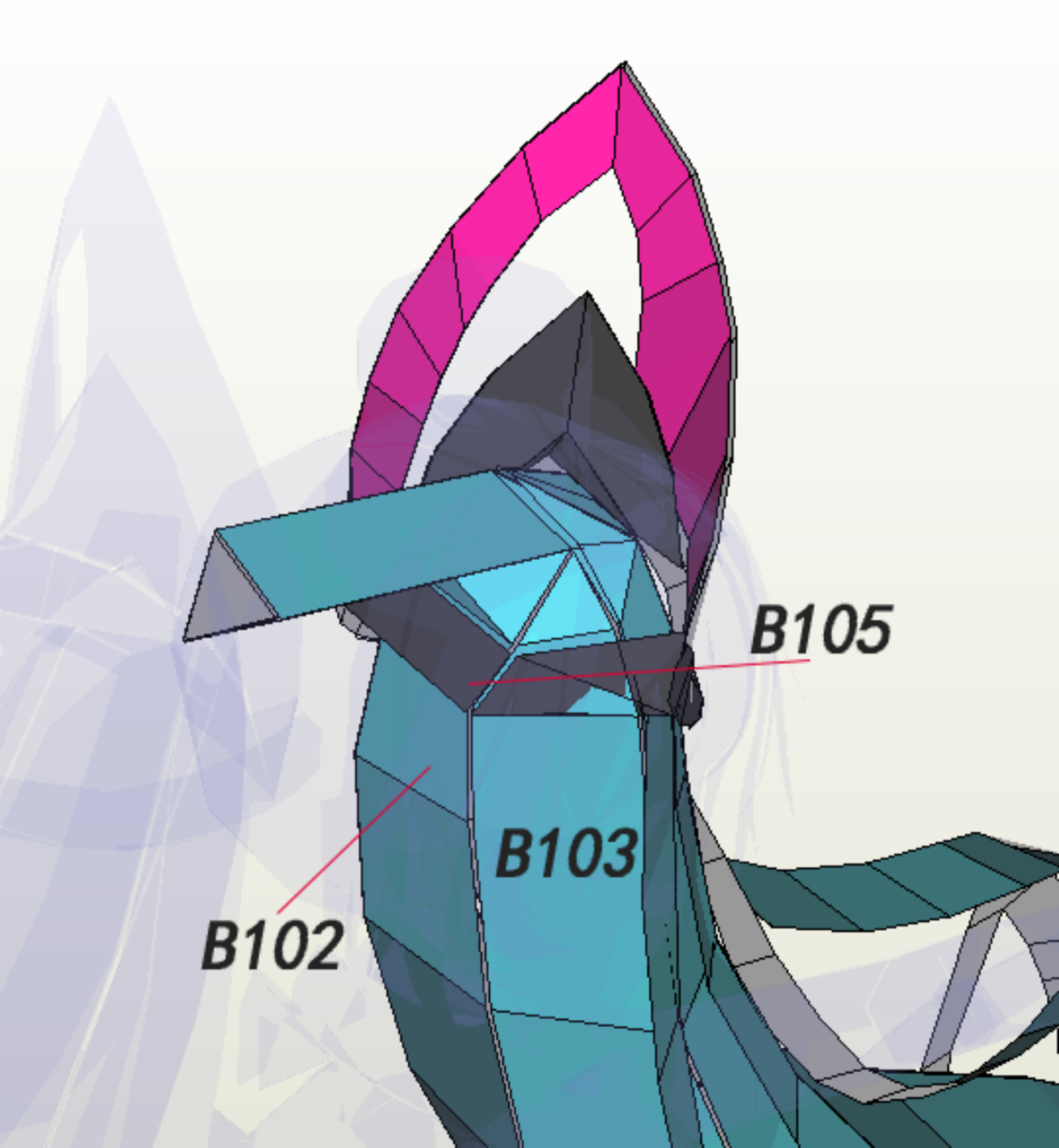

B102

B103

B105

B105a

B105

b104

B107

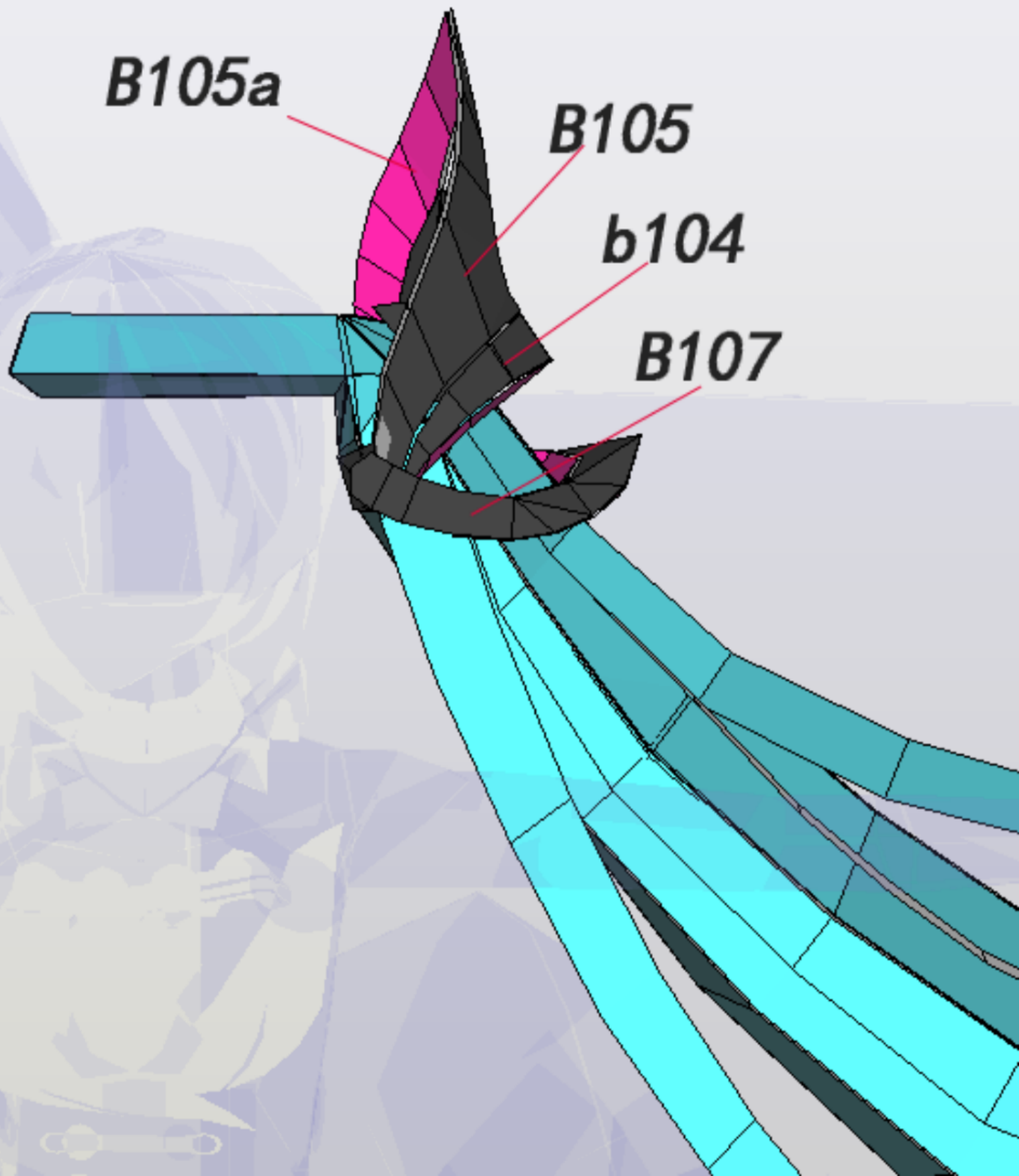



先把散热片固定在灯箱上，注意穿洞位置对齐



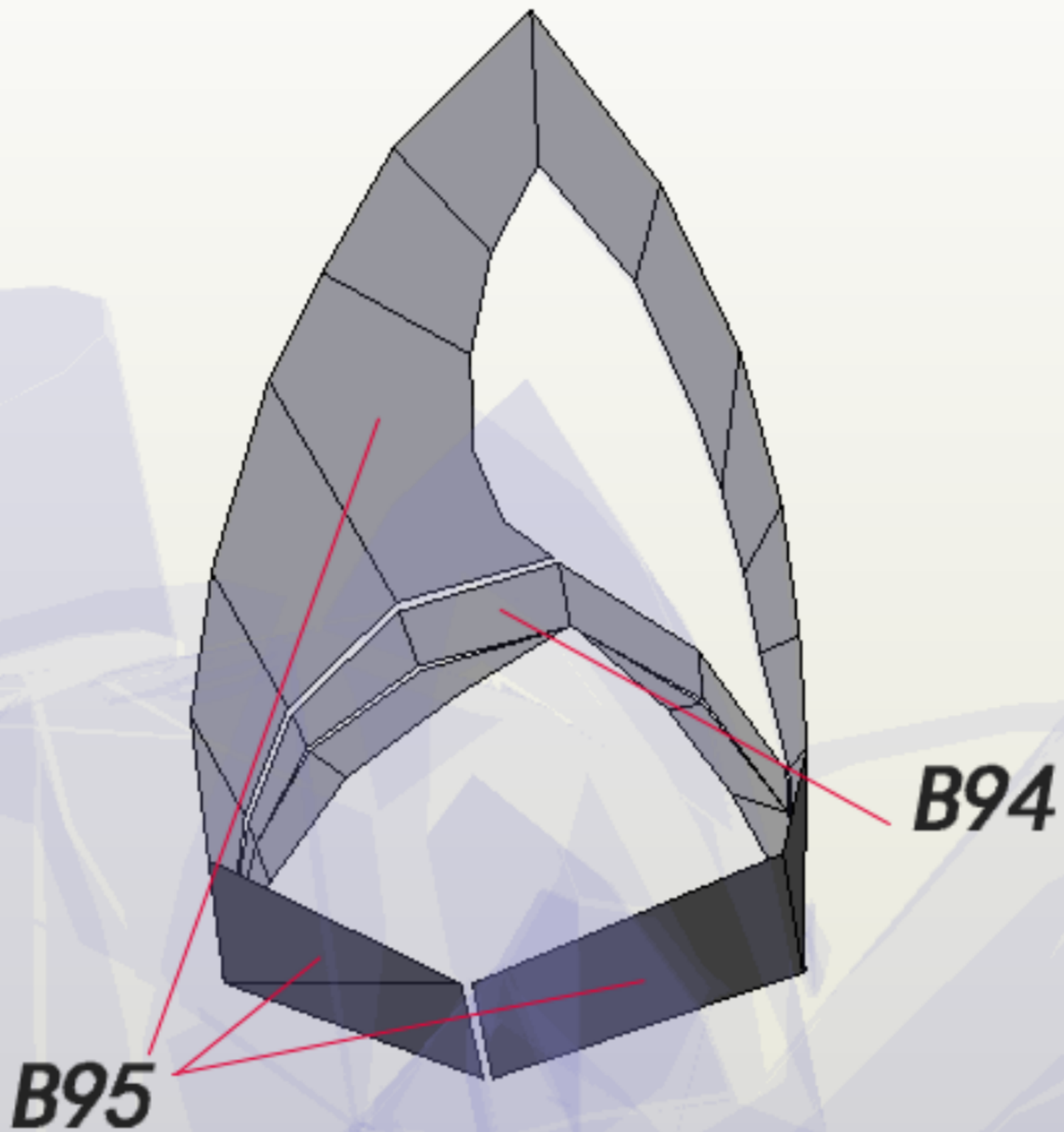

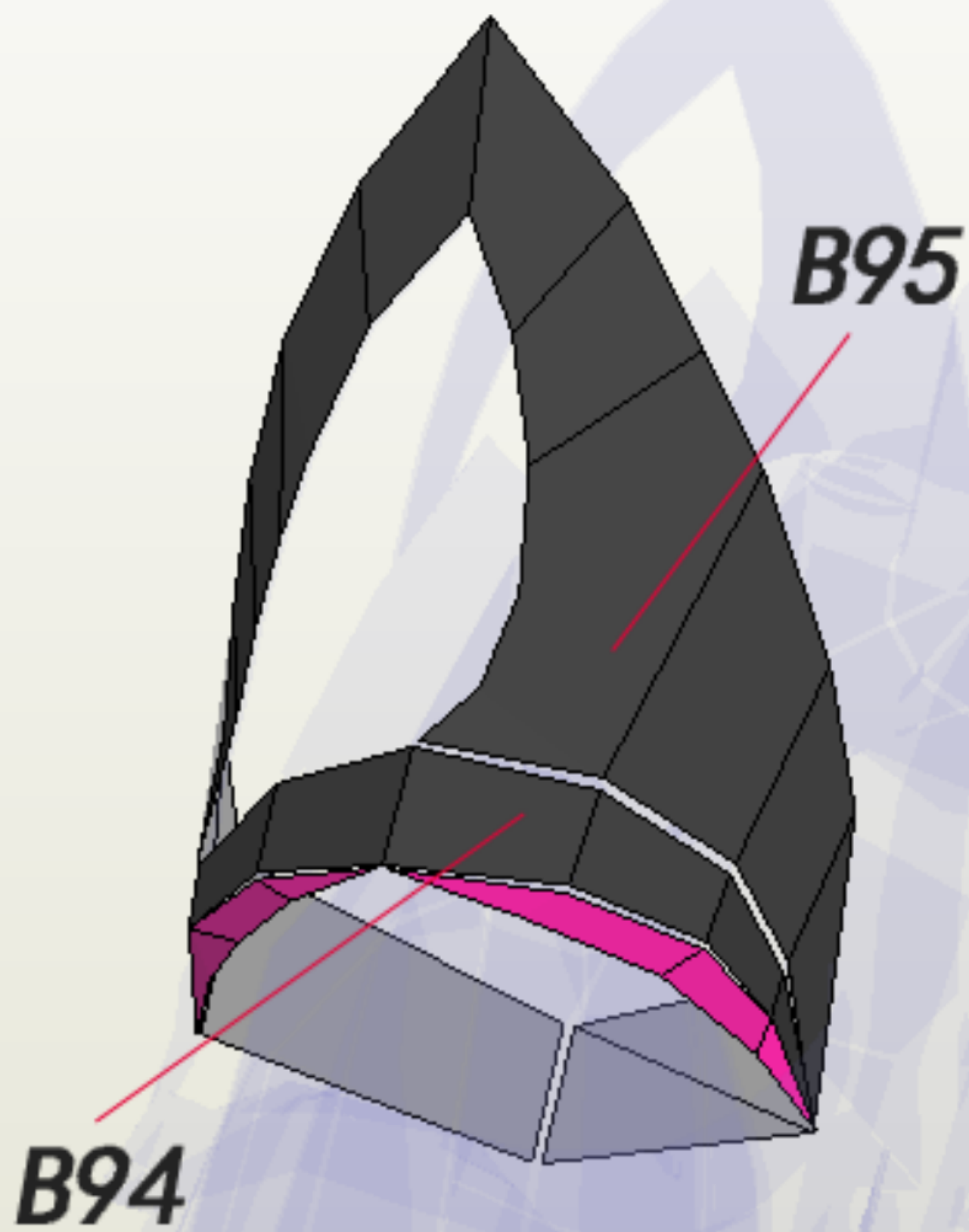

B96

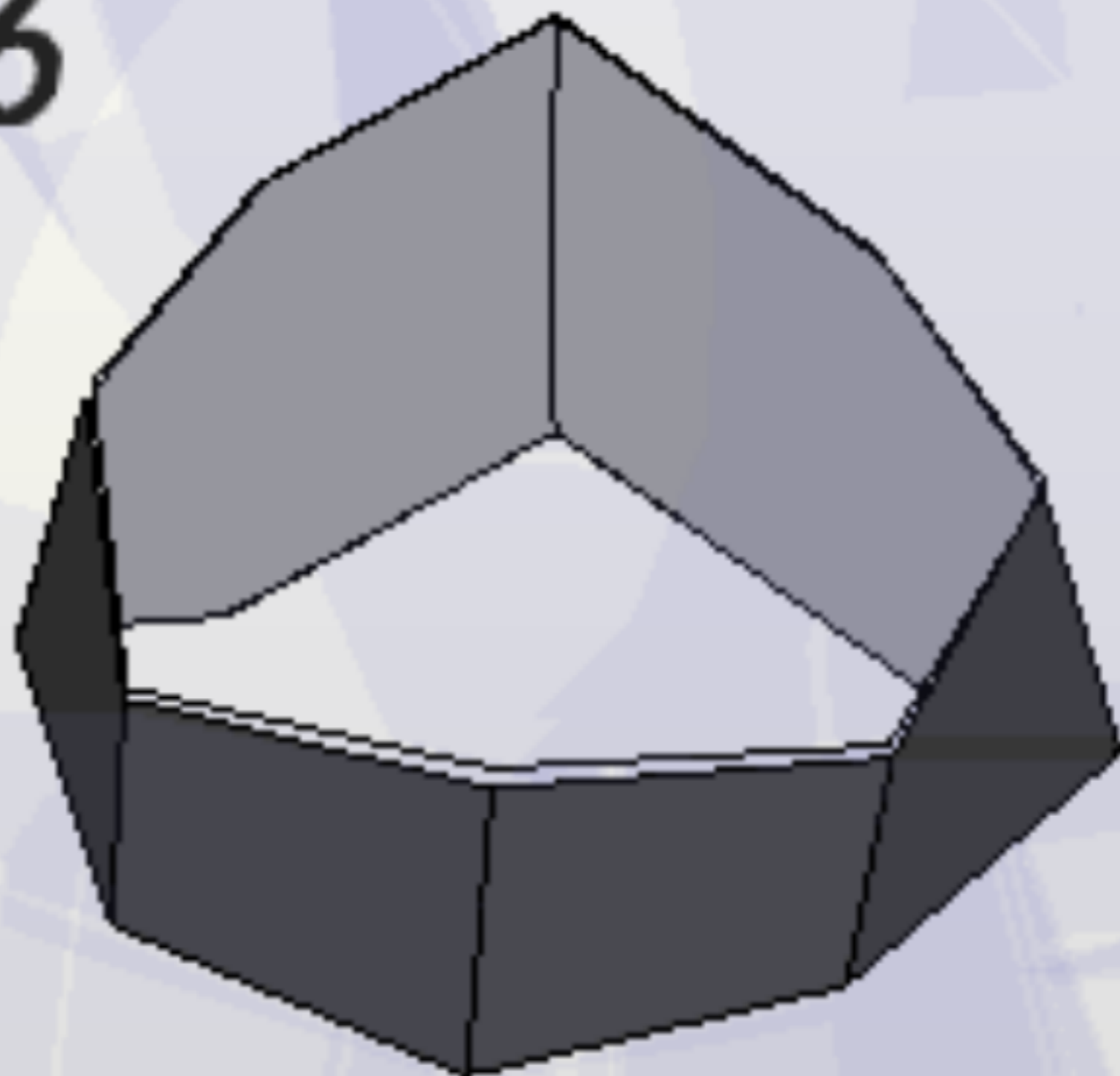

B95a

